

DESTINATION ALASKA » Tips on Preparing Your Rig » Consider an RV Caravan

# TRAILER LIFE

FOLLOW THE ROAD TO ADVENTURE

FEBRUARY 2012

## SPACE CAMP RAM 1500 AND STARCRAFT TRAVEL STAR



**Rock Steady**  
Winfield Trailer Stabilizers

**Room to Spare**  
Jayco Eagle 3330 RLTS

**15** HOT RV PRODUCTS



www.trailerlife.com

Go To: **TRAILER LIFE**.com

User Guide

Contents

**It's the  
same thing  
day after day  
after day.**



# QUALITY



\*The Ford F-150 LD received the lowest number of problems per 100 vehicles among large pickups in the proprietary J.D. Power and Associates 2011 Initial Quality Study.<sup>SM</sup> Study based on responses from 73,790 new-vehicle owners, measuring 234 models and measures opinions after 90 days of ownership. Proprietary study results are based on experiences and perceptions of owners surveyed in February-May 2011. Your experiences may vary. Visit [jdpower.com](http://jdpower.com).

TY

F-150: "Highest Ranked Large Pickup in Initial Quality in 2011" by J.D. Power and Associates.\*

**This is the future of truck**  
**THE 2012 F-150**

[FORD.COM](http://FORD.COM)



# CONTENTS

February 2012 Volume 72 Number 2



## Features

- 12 ASH MEADOWS NATIONAL WILDLIFE REFUGE**  
Less than two hours from the bright lights of Las Vegas, 23,000 acres of natural beauty offer more than two dozen forms of unique flora and fauna
- 15 DREAM SEQUENCE**  
Thinking about that once-in-a-lifetime trip to Alaska? We're here to help
- 24 MILES FROM MARDIS GRAS**  
Don't get caught up in the New Orleans revelry; spend some time exploring scenic Highway 71
- 32 LOVELAND, COLORADO**  
America's "Sweetheart City" is a great place for culture, wildlife and, of course, romance
- 38 JUST RIGHT**  
Pairing the Ram 1500 and new Starcraft Travel Star Galaxy for "out-of-this-world" livability
- 46 SEMA SHOWTIME!**  
A sampling of some of our favorite products offered at this year's popular aftermarket-product showcase
- 52 2012 JAYCO EAGLE 3330 RLTS**  
Triple-slide travel trailer offers residential amenities and wide-open living
- 54 ROCK STEADINESS**  
Winfield stabilizer systems for landing and scissor jacks keep the trailer's rock-and-roll to a minimum while in camp

## Departments

- 5 DRIVER'S SEAT**
- 6 LETTERS**
- 6 SNOOK'S NOOK**
- 
- 8 AROUND THE BEND**  
News, events, people, places, parks & RV trends
- 9 RV ACTION LINE**  
We take action to resolve conflicts between consumers and RV dealers or manufacturers
- 10 HITCHED**  
Why we loved traveling through Alaska as part of an RV Caravan
- 60 PERFORMANCE CORNER**
- 61 FREE TRAVEL INFORMATION**
- 64 RV CLINIC**  
Straight talk from the *Trailer Life* tech team
- 84 10-MINUTE TECH**  
Tried-and-true tech tips from our readers
- 91 AMERICA'S OUTBACK**  
A Big Mac attack isn't the only reason to visit McDonald's, which offers free Wi-Fi to travelers



### ON THE COVER

The test crew for the Ram 1500 and the Starcraft Travel Star enjoys a relaxing weekend at a Southern California campground. See story on page 38.

Photo by Rich Cox Photography



**TRAILER LIFE (USPS#454-970)** is published monthly by GS Media & Events (a division of Good Sam Enterprises, LLC), 3300 Fernbrook Lane N #200, Minneapolis, MN 55447. Periodicals postage paid at Plymouth, MN 55447 and additional mailing offices. The annual subscription rate is \$15.97 per year in the U.S. For Canadian & International subscriptions, add \$12 per year. U.S. funds only. **Postmaster:** Send address changes to Trailer Life, P.O. Box 5860, Harlan, IA 51593-1360. **Canadian Return Address:** GS Media & Events, 4960-2 Walker Road, Windsor, Ontario N9A 6J3. Publication Sales Agreement #40012332.

# DRIVER'S SEAT

by **Kristopher Bunker**



## NOW IS THE TIME

**Y**our eyes do not deceive you ... the 2012 Guide to Towing is here! Each year, the arrival of the Towing Guide represents a great opportunity to do some cursory research and take the plunge by purchasing a new tow vehicle. This year's guide features more than 700 listings, and is packed with information about towing packages, hitch types and helpful towing tips — all of which offer important tips for newbies and old salts alike.

The timing of our annual towing guide also coincides with one of the largest after-market-product showcases from the Specialty Equipment Market Association, known as the SEMA show.

Each year, the SEMA show attracts hundreds of product manufacturers to the bright lights of Las Vegas, and this year we found plenty of exciting gear that should help enhance your RVing experience. Beginning on page 46, we're certain you'll find something sure to catch your eye — or, perhaps that of your dearest loved one. I know, an RV-related product may seem like a strange gift for Valentine's Day, but it sure beats chocolates. (And how many bouquets of roses come with a two-year warranty, anyway?)

For a more conventional Valentine's Day celebration, why not head to Loveland, Colorado, for a taste of all things romantic — with some wildlife and culture mixed in? Beginning on page 32, we offer up a sampling of the many activities available in this charming city, which is best known for its annual Valentine Card remail program that postmarks your beloved's special letter with the city's iconic name.

Or you may choose to leave the sweet nothings behind, and set off on the trip of a lifetime to Alaska. The first decision: Go it alone or as part of an RV caravan? Beginning on page 10, full-timer Barry Zander explains why an Alaska caravan worked for him and his wife — even though they were initially reluctant to join a group.

Once that's been settled, it's time to get your rig ready for the trip. Again, Zander has the answers, this time discussing what visitors should expect when traveling to the "Land of the Midnight Sun," and what preparations should be taken in order to ensure their travels go off with few, if any, incidents. Turn to page 19 for more.

Your trip will be even more memorable with just the right tow vehicle and trailer combination. If now is the time to get a new family-friendly trailering combo, turn to page 38. "Just Right" features our test of the Dodge Ram and Starcraft Travel Star trailer, a lash-up that may be an ideal fit for you.

And finally, now is the time for me to sign off from the driver's seat for the last time. Thanks for the memories, and hopefully I'll see you down the road ... 🚗

# TRAILER LIFE

FOLLOW THE ROAD TO ADVENTURE

## EDITORIAL

**Publisher** Bob Livingston  
**Editor** Kristopher Bunker  
**Managing Editor** Laura Michaels  
**Associate Editor** Amanda Lepinski  
**Consulting Editors** Wes Caughlan, Ken Freund, Jeff Johnston, John Prusak  
**Contributors** Stuart Bourdon, Marleen Canniff, Len Cousineau, Bill Graves, Pamela & Guy Selbert, Irene Middleman Thomas, Gary & Monika Wescott, Barry Zander

## CREATIVE

**Art Director** Rick Damien

## PRODUCTION

**Vice President of Production** Bob Dawson  
**Production Manager** Angela Schmieg

## CIRCULATION

**Circulation Director** Jill Anderson  
**Senior Marketing Manager** Kathryn Knudson  
**Administrative Assistant – Audience Development** Molly Sullivan

## CUSTOMER SERVICE

Call (800) 825-6861 Email [trailerlife@cdsfulfillment.com](mailto:trailerlife@cdsfulfillment.com)  
Visit [www.trailerlife.com](http://www.trailerlife.com) part of the RV.NET family



**President/CEO** Marcus Lemonis  
**Executive VP/CFO** Tom Wolfe  
**Senior VP/Group Publisher** Bob Livingston  
**Chairman Emeritus** Art Rouse  
**Publisher Emeritus** Bill Estes

## EDITORIAL/BUSINESS OFFICE

GS Media & Events, 3300 Fernbrook Lane N #200, Minneapolis, MN 55447  
Call (800) 848-6247 Email [info@trailerlife.com](mailto:info@trailerlife.com)

## ADVERTISING

**Ventura, California**  
**VP/National Sales** Terry Thompson  
**RV Marketplace** Sue Seidnitz

## National Advertising Sales (Southeast Region)

Tacy Hendershot (772) 0288-0387  
1010 SW Lighthouse Drive, Palm City, FL 34990  
Tel (772) 288-0387, Fax (772) 288-0085

## National Advertising Sales (Northeast Region)

Lou Cicirelli (954) 297-9234  
1400 NW 108th Avenue, #266, Plantation, FL 33322  
Tel (954) 297-9234

## National Advertising Sales (Seattle, Washington)

Scott Oakes (206) 283-9545  
John Marciano (206) 235-7555  
1818 Westlake Avenue N, #420 Seattle, WA 98109  
Tel (206) 283-9545, Fax (206) 283-9571

## Detroit, Michigan

Crompton Holdings Scott Crompton  
2031 Kings Highway, Shreveport, LA 71103  
[scottcrompton@mac.com](mailto:scottcrompton@mac.com)  
Tel (334) 546-7243, Fax (334) 356-7740

Permission to reprint or quote excerpts granted only on written request and when full credit is given. *Trailer Life* and *Roads to Adventure* are registered trademarks and incorporated in *Trailer Life* magazine. *Trailer Life* is copyrighted 2012 by Affinity Group Inc. in the United States and Great Britain. All rights reserved.

*Trailer Life* does not knowingly accept deceptive or misleading advertising. If you have a contrary experience with respect to any merchandise or service represented herein, please write to *RV Action Line*.

**Editorial submissions:** Written queries only. Although every precaution is taken, the publisher assumes no liability for the return or safety of unsolicited manuscripts, queries, photographs or illustrations. Manuscripts submitted for publication must include complete return postage.

**Privacy Statement:** We recognize that your privacy is very important to you, and we're committed to helping you protect it. You should know that we will never intentionally share your name, address and other personal information with anyone for their use if you have asked us not to do so. When you subscribe to *Trailer Life*, please tell us if you don't want your name and address shared with other reputable companies, or if you don't want to receive our marketing offers. We'll mark your account for a three-year period so that it will not be selected for products and/or services offers, which you've told us you are not interested in receiving. If you change your mind, just get in touch with us and ask that we include you in future offerings. You can ask to not be included in future offerings at any time, and it'll be taken care of promptly. Please contact us at *Trailer Life* Mail Preference Service, P.O. Box 5860, Harlan, IA 51593-1360, email us at [trailerlife@cdsfulfillment.com](mailto:trailerlife@cdsfulfillment.com) or call us at (800) 678-1201. Please note that this policy does not apply to email marketing. We will not send you commercial emails unless you have authorized us to do so.

# LETTERS ❖

from our **Readers**

“He made me feel as though I was right alongside him for all of his fishing, bicycling and golfing (mis)adventures.”



## DO THE MATH!

I'm writing in regards to the letter from Charles Jennings ("EcoBoost Addition," December 2011). If he is being quoted at \$4,500-\$6,000 more for the Ford EcoBoost, he needs to find a new dealer. The EcoBoost lists for only \$750 more than the 5.0-liter V-8. Plus, by ordering instead of buying off the lot, you can get only the options you want without paying for extras.

If Jennings buys an EcoBoost he'll be shocked at the combination of power and economy. On a recent 1,100-mile trip, I averaged 11.4 mpg towing a 9,000-pound trailer. Driving solo I'm averaging 22 mpg highway. That's 35 percent better than my 2004 Ford 5.4-liter got.

**William Sill**, via email

## YOU'RE WELCOME?

Although I do not subscribe to your fine magazine, I always read my friend's issue every month.

You outdid yourselves with "Our Winter RV Adventure" in the December 2011 issue. If the article can get just one RVer to stay home and try this idea out in the winter, maybe I could have a chance to camp here in one of our state parks in my own home state. Thanks a million.

**Rose Porter**, Sun City Center, Florida

## HAPPY TRAILS

I just finished reading Bruce Leonard Jr.'s

To contribute to this column, write to 3300 Fernbrook Lane N., Suite 200, Minneapolis, MN 55447, or e-mail [info@trailerlife.com](mailto:info@trailerlife.com).

"The Outsider" in the December 2011 issue ("Things Change"). I am not ashamed to say that after the first paragraph I felt a tear well in my eye. I have been a subscriber for almost eight years now, looking forward to reading his column every month. He made me feel as though I was right alongside him for all of his fishing, bicycling and golfing (mis)adventures. I would laugh out loud as he described his trials and tribulations, all the while wishing I had his job! Thanks for taking me along on all those trips, Bruce. Good luck with whatever life throws at you next.

**Kevin Martin**, Woodhaven, Michigan

## GLAD TO BE GREEN

Thank you for the "Going Green" article in the December issue. The article was very

informative, especially pointing out TRA is "arguably the industry standard" third-party green certifier, and that LEED is another standards organization. I had not really noticed the different certifiers prior to reading this article.

Please continue to publish eco-friendly articles such as "Going Green," and also consider articles about construction techniques, including R-values, in the future.

**Glenn Benfield**,

Kannapolis, North Carolina

## OOPS!

The "All-Weather RVs" feature in the January 2012 issue contains incorrect information for Northwood Manufacturing. The phone number should be (800) 766-6274. The website is [www.northwoodmfg.com](http://www.northwoodmfg.com). Our apologies for the confusion. ☹

## SNOOK'S NOOK



"I think I just ran over a bear!"

# THE BOOKS ARE FREE

THE ADVENTURE IS PRICELESS



## GET YOUR **FREE** ALASKA AND YUKON GUIDES!

Go on an adventure you'll treasure the rest of your life. Request your **FREE** official travel guides today.

Return our reply card or request the guides online at

**[AlaskaYukon.net/TL](http://AlaskaYukon.net/TL)**

Alaska, Circle 102 on Reader Service Card

# AROUND THE BEND

NEWS • EVENTS • PEOPLE • PLACES • PARKS & RV TRENDS



## ROMANCE JOINS HISTORY

The centerpiece of a small park along Bayou Teche in St. Martinville, Louisiana, is a magnificent live oak. This aged behemoth is known as the “Evangeline Tree.” According to legend, it was under this tree two and a half centuries ago that Evangeline and Gabriel, the Acadian lovers in Longfellow’s epic poem, “Evangeline,” were reunited after a 10-year separation.

Originally from Nova Scotia, they and hundreds of other Acadians had, history tells us, been deported in 1755, sent off to various locales for refusing to swear allegiance to Britain. Many would never see each other again.

But according to the poem, the “real Evangeline,” Emmaline Labiche, would not give up the search for “Gabriel,” Louis Arce-neaux. Her joy on finding him was short-lived, though, as he explained he had given up hope of ever seeing her again, and had married someone else. Evangeline soon died of a “broken heart.”

South of the park, “romance joins history” at the Longfellow-Evangeline State Historic Site. Acadians from Nova Scotia and French aristocrats fleeing the French Revolution had come to the area seeking refuge. The historic site was a cattle ranch turned indigo plantation owned by wealthy early 18th century Creole Charles Olivier.

His home and other historic buildings have been restored and can be toured, and exhibits at the visitor center tell the story of the exile and Acadian life here. Another “Evangeline Tree,” even grander than the one at the park, stands outside the house.

Longfellow-Evangeline State Historic Site, (888) 677-2900, [crt.state.la.us/parks/ilongfell.aspx](http://crt.state.la.us/parks/ilongfell.aspx) — *Pamela Selbert*



## NEW TRAILER ... NEW TRAILER ... NEW SURV ...

Echoing throughout the RV industry is news about brand-new RV manufacturers making a splash with brand-new travel trailers designed to be lightweight and affordable. One such example is Echo Manufacturing, a new manufacturer offering its first product launch of lightweight travel trailers and a multipurpose SURV — the American Spirit, the Canadian Spirit and the Bandit APH. The two Spirits are travel trailers with six floorplans ranging from 19 feet to 27 feet, a dry-weight range from 2,939 pounds to 4,257 pounds and a base msrp range of \$12,453-\$13,713. The Bandit is an SURV with 19-, 24- and 32-foot floorplans and an msrp range of \$15,820-\$22,820. The Bandit’s 19-foot model weighs in at 3,350 pounds dry, with a cargo-carrying capacity of 3,270 pounds.

For more information, call (877) 495-1546 or visit [www.echorv.com](http://www.echorv.com).

## SUPER DIRECTORY

*Trailer Life Directory* and Woodall Publications will join forces to offer a single North American campground directory in 2013.

The directory will utilize the popular *Trailer Life* 10/10/10\* rating system, with some enhancements borrowed from the *Woodall's* rating system as well.

Improvements will include state and provincial points of interest, the RVers “Bucket List” for 2013, tips to improve your RV and camping lifestyle, *10-Minute Tech* tips, RV-maintenance advice, how to buy or sell an RV, dealers and service-station locations, games, puzzles, recipes, coupons and more. The directory will also spotlight the Good Sam RV Park and Resort network, the largest affiliated park network in North America, featuring more than 1,700 RV parks and resorts where Good Sam members can save 10 percent on nightly camping fees.

The *Trailer Life* and *Woodall's* 2012 Directory editions will still be available separately to consumers this year. 📱



**Good Sam**





## DILEMMA-NATION

Upset that their trailer repairs wouldn't be covered because the unit was out of warranty, two readers asked *RV Action Line* to step in:

We purchased a 2008 Heartland Sundance 2900RK fifth-wheel in July 2007 from the Jim May Heartland dealer (which is no longer in business) in Findlay, Ohio. About a week into our first trip we noticed a basketball-size spot above the bedroom window delaminating. We immediately alerted the dealer to the problem. After a lengthy back and forth with the dealer and the manufacturer, a local body shop fixed the spot.

Fast forward a year later and the trailer was out of warranty by just a few weeks. When we uncovered our unit we found extensive delamination on the entrance side, the entire back panel and a small spot underneath the bedroom slideout. We immediately contacted the dealer once again, who was diligent in working with us and Heartland to get this resolved. I emailed numerous pictures and was in constant contact with someone in charge. This went on for about three months. Finally Heartland agreed to repair all the delamination if we brought the trailer out to Elkhart, Indiana. We delivered the trailer in April 2009.

Heartland replaced the entire back panel and fixed each spot we pointed out. We felt at the time the whole panel on the entrance side should be replaced, but it wasn't. We didn't press the issue, as we were just grateful for what they were doing. We picked the unit up in June.

All was well until we uncovered it this year. We again noticed a spot where the fiberglass bubbling above the bedroom window. And now there were two cracks in the fiberglass in that area and one by the rear compartment. This time I contact-

ed Heartland directly and sent emails and pictures as requested. Our claim was eventually denied due to the trailer being out of warranty.

Even though the trailer is out of warranty, the issue we are having now is a direct result of not properly fixing the fiberglass the first time. We realize that a company has to put a cut off somewhere, but this is an ongoing problem. Thank you for any help in this matter.

**Terry & Linda Aukerman**, Findlay, Ohio

We receive hundreds of letters each year about problems arising after the warranty has elapsed. At that point it is essentially up to the manufacturer as to whether it chooses to cover the repairs.

However, the Aukermans' case is a bit different in that there could be no denying that the current problems they were experiencing were directly related to the past repairs — or lack thereof.

We sent the Aukermans' complaint to Heartland, who responded:

We contacted the customers and offered them the opportunity to return the trailer to Heartland, where we will perform the needed repairs at no charge to them.

The customers have accepted this as a fair resolution. Therefore, we consider this issue resolved.

**James Fenner**,

Customer Service Manager,  
Heartland Recreational Vehicles LLC

After exhausting all other resources without success, please forward information (typewritten only) with copies of appropriate bills and correspondence to *RV Action Line*, 3300 Fernbrook Lane N, Suite 200, Minneapolis, MN 55447.

Please include a self-addressed, stamped envelope. No phone calls.

*What's New!* from **NORTHWOOD**

*Arctic Fox*  
*Silver Fox Edition*

**NEW**



New Gray Front Cap w/LED Hitch Lights, Exterior Convenience Center, Solid Surface Counters, Certified Stor-Mor 5th Wheel Chassis, much more...

*Classic*

**NEW**



NEW Aluminum Laminated Walls in Every Model  
Fiberglass Front Cap, Certified Northwood HD Chassis

**NASH**

*DLX*

**NEW**



DLX Standard Features: Deluxe Gray Fiberglass, Generator Ready, Equiflex Suspension, Microwave, Stabilizer Jacks, 10 Gal. Water Heater, Power Awning, Rear Receiver for Hitch, Black Water Flush, Exterior Shower.

*LT*

**NEW**



Nash LT with Rugged-Light Duty Models, all with Triple Layer Laminated Continuous One Piece Fiberglass Walls & Northwood Chassis

**DESERT FOX**

**NEW**

295B



Desert Fox Body Wrap Icon Graphics, Stainless Appliance, Kicker 200 Watt Sound, Signature D-Fox Etched Panels & Embroidery, plus optional: Exterior Gear Locker, Pressure Washer, Air Compressor, and Convert-a-U-Dinette / Lounge & Ramp Room...much more!

**NEW**



**NEW**

Check out everything new on our **NEW** WEBSITE:  
**WWW.NORTHWOODMFG.COM**



MORE NORTHWOOD

Northwood Manufacturing Inc., Circle 125 on Reader Service Card

# HITCHED ❖

by Barry Zander



## WHY CARAVAN?

**“THIS TRIP TO ALASKA THAT WE’LL NEVER FORGET WAS WELL WORTH THE MONEY WE INVESTED”**

**C**onsidering your adventurous spirit — you know, the one that got you to buy an RV in the first place — I’m sure you don’t want to travel like a baby duckling following behind mama’s tail feathers. I also know that you don’t want someone telling you where to go and when to arrive at the next RV park. And what you really don’t want is to pay all that money for an RV caravan. It’s just not your style.

Ours either. Freedom. Independence. Budget. Those were the big three reasons we said we would never want to participate in a caravan. However, staring up at that great unknown between the Northwest and Alaska, we took weeks to weigh benefits against prejudices.

What opened us to consideration of a caravan was a chance meeting with a wagonmaster (leader) from one of the top caravan companies. Darn if he didn’t make several good arguments for joining a caravan ... well, after all, that’s his job.

Only thing was, we didn’t feel comfortable with his explanation of how he conducts his caravans. But wait, that’s a

good thing, because while other trailerists would be more comfortable with the security of a regimented trip, that’s not our style. We decided after listening to him that we didn’t want to visit Alaska as part of a group ... but there were enough nuggets in his sales pitch to keep us thinking about it long after we left his motorhome office.

Two things got Monique (the navigator) to research and make a couple of calls to RV caravan companies. First, there was that incredible expanse of the unknown in the Yukon and Alaska. Magazine articles, Mileposts and other sources of information gave us some insight, but the prospect of her spending hours on the road looking at maps, worrying about fuel availability and where we would spend the night seemed like it could make the trip more of a hassle than a pleasure.

Second, a tour company’s brochure she picked up in an RV park laundry room had the itinerary of all of that company’s tours. When I looked at the caravan for New Orleans (my hometown) for the upcoming year, I realized that it was an excellent plan — better than what I would have put together. For me, that qualified the company to be among those we considered.

Next decision for the Alaska trip was the length of the tour and which stops were on the route. Monique found the one she liked best, so we called the company and asked more questions.

Let’s get back to those three concerns I mentioned earlier and go on from there.





**Despite our reservations, visiting Alaska in an RV caravan was a wise decision; without it, we may have missed out on fun activities like this raft expedition.**

**Freedom:** We were assured that we could go where we wanted using the daily trip guide to know what we would see each day. In the mornings, we could leave anytime, often between 8:30 and 10, and arrive at the next destination within a reasonable time period. (There is a good reason for that. The staff member, called “the tailgunner,” leaves last and is on the road making sure no one has problems. When problems arise, it’s the tailgunner’s job to get the traveler to the next stop.) The point is, we had a choice of traveling on our own schedule or we could team up with others in our group.

**Independence:** We stopped at restaurants and attractions on the way at our own pace ... or we didn’t stop. The choice was ours.

**Budget:** This is the biggest benefit. The trip was, for us, a strain on our financial resources. We had the money, but our priorities made it a tough decision. After having paid all that money, we kept wondering whether we had spent our money wisely. I think the first time I was comfortable with the decision was when we arrived at the Columbia Icefield in British Columbia. If we had been on our own, when we saw the \$49 senior rate to take the Ice Bus to the glaciers, we would have quickly said, “No, way!” But, since it was already paid for with the cost of the caravan, we went — and we’re very glad we did.

Cruises, parks with full hookups at almost every stop, vaudeville shows, walking tours, museums and more ... all that stuff costs money that we would have had to agonize over every time before pulling out the wallet, and in most cases we wouldn’t have done it. This trip to Alaska that we’ll never forget was well worth the money we invested.

Previously, we never even considered traveling with other RVers in our years on the road. Too many personalities in conflict, each with his and her own interests. For us, two months interacting with all these people was not something we wanted to experience. Yet, much to our surprise, we actually loved our group.

It was a special pleasure when we pulled into a donut shop a hundred miles from nowhere to be greeted by our friends who had also stopped. “Did you see that mama bear at mile 136?”

Many evenings we had social gatherings, sometimes with munchies or potlucks; other times, staff-prepared dinners. It was an optional time to relax and talk about the day’s journey.

Three more benefits of taking the caravan:

(1) On trips into the unknown, many people find it comforting to have the tailgunner behind them in case the unexpected happens. They know a friend will be along soon.

(2) The wagonmaster and his company knows where to go and — maybe just as important — where not to go, plus members of the group get guidance on the attractions along the way, whether it’s visiting Alaska, battlefields, national parks, etc.

(3) One wife in our group said she didn’t like the prospect of having only her husband to talk to for two months. Sounds like a joke, but she wasn’t kidding.

If you’re weighing the possibilities of caravanning, besides reputation of the tour company and the route, I suggest that the most important aspect is the wagonmaster. Some are highly regimented. Other tour leaders, like ours, are pretty loose, which takes a special leadership talent considering the different personalities in the caravan.

Never say never. We went to Alaska mainly to check it off on the list of states we’ve visited. About three weeks into the tour, we heard ourselves saying, “When we come back to Alaska, ....” We were adamant that caravanning was not for us, but we went. And we’ve already signed up for another trip: This one for Mardi Gras in, where else, but N’Awlins. 🗣️

Tell us about your RV caravan experience. Write us at [NeverBoredRVers@gmail.com](mailto:NeverBoredRVers@gmail.com).

# ASH MEADOWS NATIONAL WILDLIFE REFUGE

by **Len Cousineau**

**V**ery few of the millions of travelers who try their luck annually in the casinos of Las Vegas are likely ever to have heard of Ash Meadows National Wildlife Refuge, and far fewer have made the 90-mile trip to this Nevada refuge's 23,000-plus acres. Yet when the cards, dice and slots are running cold, lovers of nature should make the hour-and-a-half trip to the northwest to experience one of the more ecologically significant locations in the world.

No, this refuge does not feature the dramatic landscapes that many of the more-famous Western national parks do, but Ash Meadows provides habitat for at least 26 species of plants and animals found nowhere else in the world, granting Ash Meadows a higher concentration of endemic life than any other local area in the United States.

Seven of the endemic species in the refuge are listed as threatened, and five are endangered. The four endangered fish species are the Ash Meadows Amargosa pupfish, the Warm Springs pupfish, the Devil's Hole pupfish and the Ash Meadows speckled dace. Although visitors can see the Amargosa Ash Meadows pupfish in most of the numerous springs and streams throughout the refuge, the best viewing of this species occurs in the blue spring pool at Point of Rocks. Since the creation of the refuge in 1984, these rare species have been protected from threats of habitat destruction and water pumping, and large-scale wetland restoration efforts are further improving their chances for survival.

Birdwatchers will thrill to the fact that more than 275 species (and counting!) of birds have been spotted within the refuge, and more than 27 species of mammals, including coyotes, desert cottontails, white-tailed antelope squirrels



and badgers, make their homes in the refuge. In the fall, desert bighorn sheep are regularly seen around the Point of Rocks boardwalk, drinking from the springs and streams. Five amphibian species and 20 reptile species also live within the refuge.

The moist environment of Ash Meadows exists within the otherwise arid region because a geological fault acts as an underground dam and forces the water in a vast aquifer system upwards, creating more than 50 seeps and springs.

Although no campgrounds exist within the refuge, RVers smart enough to escape the neon of Vegas to visit Ash Meadows should consider themselves lucky. An RV park and other accommodations can be found nearby at the Longstreet Casino or Death Valley Junction. 🚐

**Ash Meadows National Wildlife Refuge**, (775) 372-5435, [www.fws.gov/desertcomplex/ashmeadows](http://www.fws.gov/desertcomplex/ashmeadows).





**YOUR RV ISN'T A CAR. DON'T INSURE IT LIKE ONE.**

Progressive covers your RV in ways auto policies don't. So if you ever get in an accident and need to leave your RV at the shop for repairs, we'll cover the cost of your hotel. Keeping family trips on the road, now that's Progressive.

1-800-PROGRESSIVE | LOCAL AGENT | PROGRESSIVE.COM

**PROGRESSIVE**



Progressive Casualty Ins. Co. & affiliates. Emergency Expense coverage is subject to policy terms. 11D00458 (06/11)

Progressive, Circle 104 on Reader Service Card

Go To: **TRAILER**  
LIFE.com

User Guide

Contents

# PROGRESSIVE® RV & OUTDOOR SHOW SERIES

## Your Chance to Win a Keystone RV!



Register to win the Rediscover America RV Giveaway online at [www.keystonervgiveaway.com](http://www.keystonervgiveaway.com) or at one of the shows listed below

Progressive Insurance New Mexico RV, Boat & Travel Show  
January 6-8 | Albuquerque, NM

Progressive Insurance North Carolina RV & Camping Show  
January 6-8 | Greensboro, NC

Progressive Insurance Colorado RV Adventure Travel Show  
January 11-14 | Denver, CO

Progressive Insurance Chicago Boat, Sports & RV Show  
January 12-16 | Chicago, IL

Progressive Insurance Washington Camping RV Expo  
January 13-15 | Chantilly, VA

Progressive Insurance New Jersey RV & Camping Show  
January 20-22 | Edison, NJ

Progressive Insurance Mid-America RV Show  
January 26-29 | Kansas City, MO

Progressive Insurance MSP RV, Vacation & Camping Show  
February 9-12 | Minneapolis, MN

Progressive Insurance Richmond Camping RV Expo  
February 10-12 | Richmond, VA

Progressive Insurance Kansas Sports, Boat & Travel Show  
February 16-19 | Valley Center, KS

Progressive Insurance North Carolina RV & Camping Show  
February 17-19 | Charlotte, NC

Progressive Insurance Atlantic City RV Show  
February 17-19 | Atlantic City, NJ

Progressive Insurance South Carolina RV & Camping Show  
February 24-26 | Greenville, SC

Progressive Insurance CO RV, Sports, Boat & Travel Show  
March 1-4 | Denver, CO

Progressive Insurance Rhode Island RV & Camping Show  
March 2-4 | Providence, RI

Progressive Insurance Virginia RV Show  
March 9-11 | Hampton, VA

Progressive Insurance North Carolina RV & Camping Show  
March 16-18 | Raleigh, NC

The Good Sam Rally presented by dish  
March 22-25 | Phoenix, AZ



Become an  
GS Events Fan



Follow us  
@GSMediaEvents

For discount tickets and the most updated  
info about any of our RV shows visit

# GSEvents.com

GS MEDIA & EVENTS

# DREAM SEQUENCE

LOOKING FOR THE ULTIMATE RV ADVENTURE? IT'S TIME TO BEGIN PREPPING FOR YOUR ROAD TRIP TO ALASKA

**H**eading north to Alaska is the ultimate RV adventure for many. The unparalleled scenic beauty, the wildlife, the mystery — whatever your reason, Alaska is truly a prime RV destination. But before you jump in your tow vehicle, hitch up the trailer and head up north, you do need to do a bit of homework to get the most out of your trip of a lifetime.

The first step in your planning might

be looking at a map of North America to see how big a chunk of the continent you will be visiting. The scope of the trip is awesome, but thousands of RVs of every kind take on the challenge every year. You won't be blazing a new trail, and you won't be alone up there — except for a few remote stretches of permafrost highway, that is.

And before you begin your planning, think about the purpose of your

adventure. Why are you willing to drive 7,000 or more miles over sometimes inhospitable roads?

The most common attractions seem to be sightseeing, fishing and fulfilling your desire to visit the “Land of the Midnight Sun” just to say, “I did it!” Your motive for going does make a difference in how you plan to make the trip. Think about your options even before you begin preparing your rig for the long haul.

Text & photos by **Barry Zander**



**TRAILER LIFE** February 2012 15

**CASTING A LINE**

A stream of RVers plying the highways of British Columbia, Alberta, the Yukon Territory and Alaska take on the trip with the idea of finding the best spot to drop a fishing line and parking for days or weeks before trying their luck elsewhere. Numerous tales have been written about the can't-miss fishing grounds, both on inland rivers and streams and in the coastal waters.

Making it easy to find a good place to fish are the stream accesses where you'll see several or even dozens of people in hip-huggers casting lines into the frigid, clear waters. For off-shore fishing, every coastal town has its fleet of boats ready to welcome you aboard for a (near) can't-miss day reeling in trophy catches.

**VACATION VISTAS**

If you have your sights set on seeing the sights, that is really a "can't-miss" experience. Everywhere you look on the way up to and throughout Alaska are incredible vistas with abundant wildlife, plus introductions to unfamiliar "First People" cultures. The expanses are punctuated by quaint towns inhabited by folks whose day-to-day lives are what you might expect of the Far North existence, where temperatures drop to 90 degrees below freezing in the winter

**GROUP THERAPY**

If you're heading up there to fish, you probably want to plan



**Installing a screen on your tow vehicle's grille helps keep debris off your radiator — and doubles as a butterfly-catcher.**

your trip yourself or just hitch up, get in the truck and drive. If you want to take in the beauty and cultures, you have a choice: you can wing it by planning the trip yourself just taking your chances, or you can join an RV caravan, which is well worth considering for your first time up there.

Why? Because there is so much to see ... and there are also many opportunities for driving a long way to take in what



*The Comfort of Air*

## Exciting News!

The Trailair® Service Center is now the  
**Lippert Components Customer Service Center!**  
1701 Century Drive, Goshen IN 46528



LIPPERTCOMPONENTS INC



**Tri Glide Air Ride Pin Box**



**JT's Strong Arm Jack Stabilizers**

**What's New?**

- Comfortable customer waiting lounge with TV and refreshments
- 5-Bay service center to accommodate more customers
- Monthly accessory upgrade specials



**Equa-Flex® Rubberized Suspension**



**Level Up™**



**Exclusive Level Up™ Indiana Installer**  
*The one and only Automatic 6-Point 5th Wheel Leveling System on the market today! Save time and energy setting up your campsite today!*

**Trailair Suspension & Hitch Enhancements:**

- Air Ride Pin Boxes
- Equa-Flex Suspension Enhancement
- Center Point Air Ride Suspension
- Wet Bolt Upgrade Kits



**New Installation Locations**

- Demontrond RV, Houston TX: Call 1-800-392-1480
- Lazydays RV, Seffner FL: Call 1-888-500-5299
- Lazydays RV (formerly Beaudry RV), Tuscon AZ: Call 1-800-306-4016
- General RV, Michigan & Illinois locations: Call 1-800-778-4878

**Call 1-866-LCI-SVC1 for more information!**  
**Visit us online at [www.lci1.com](http://www.lci1.com) or shop online at [store.lci1.com](http://store.lci1.com)**



**New Installation Locations**

Lippert Components, Circle 106 on Reader Service Card



turns out to be a disappointing sight. Many of the caravan companies provide RVers with a chance see a lot in a short time, with the amount of time on the road part of the reason to choose one company or route over others. Also, they will literally steer you in the right direction for sampling much of what Alaska has to offer, and will place emphasis on safety for members of their group.

As you can imagine, once you get out of southern British Columbia (or Alberta, should you choose a Montana takeoff point), you will soon be encountering hundreds of miles of beautiful scenery witnessed from lonely roads. You will want to do everything practical to have your tow vehicle and trailer rough-road ready.

The following are some of our top tips after our Alaska experiences:

### TIRES & SUSPENSION

Don't risk the trip on unreliable tires. You can't call for a tow truck where there is



**Inspectors at checkpoints conduct thorough searches; know the laws ahead of time.**

no phone service for 100-plus miles, and the time and money wasted will greatly diminish the enjoyment of your adventure. And while you're at it, it's a great idea to have your vehicle thoroughly checked out, especially the suspension, before starting the journey. Don't risk

having an undependable battery, and be certain to get your trailer's LP-gas topped off before leaving the United States.

### FUEL

As a rule, you should always carry extra fuel. You may expect to get gas or diesel

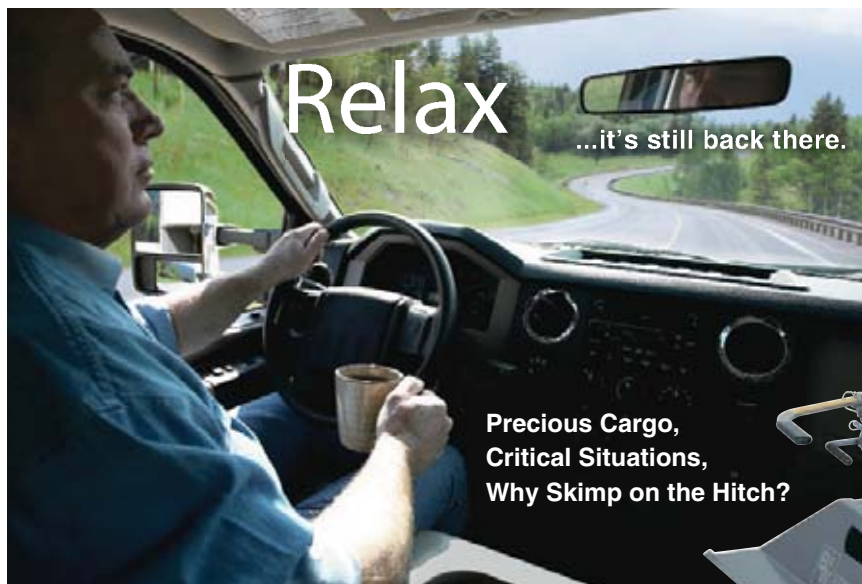

Relax

...it's still back there.

**Precious Cargo,  
Critical Situations,  
Why Skimp on the Hitch?**

The ride's so smooth,  
you could forget you're towing.

It's why you chose the

**B&W  
Companion**



**The B&W Companion.** No Rattling. No Jerking. It's nearly an 'air-like' ride. If you've ever pulled a fifth-wheel with another hitch, you know how stopping and starting can make you spill your coffee. That's why we engineered our hitch with jaws a full inch thick that mate with your kingpin perfectly. Indestructible polyurethane cushions the places where other hitches have metal to metal contact. We even integrated a shock absorber to give you stability and allow gentle side-to-side movement without the slamming. This is a ride you deserve to experience!



[www.turnoverball.com](http://www.turnoverball.com)

B&W Trailer Hitches • 1216 Hwy 224  
Humboldt, KS 66748 • 800-248-6564

B&W Trailer Hitches, Circle 107 on Reader Service Card

## Rob's RV Clinic

42846 White Elm Dr.  
849-555-3284

James Smith		July 22
882 Thomas Ct., Smithton, OH		
849-555-6418		
<input type="checkbox"/> Noise	<input type="checkbox"/> Engine	<input type="checkbox"/> Electrical
<input type="checkbox"/> Vibration	<input type="checkbox"/> Tires	<input type="checkbox"/> Water
		Amount
1	Refrigerator	\$ 1,456
2	Auxiliary Generator	\$ 1,727
3	Waste system	\$ 3,390
4	Fresh Water System	\$ 849
5	Roof A/C	\$ 4,495
6	Heating Assembly	\$ 1,104
7		
8	Subtotal	\$ 12,066
9	Less Deductible	\$ -100
	Total	\$ 11,966

Thank You

# THE BUCK STOPS HERE

"I paid \$1,471.08 for a Good Sam Extended Service policy but they paid \$3,711.07 to replace the AC blower motor in my motorhome. And to top it off, the claim process was really easy!"

-Don. E. Kingsburg, CA

**THE GOOD SAM EXTENDED SERVICE PLAN** lets you pass the buck on unexpected major RV repairs that can run into thousands of dollars out of your pocket. Better than an extended warranty, Good Sam ESP is an affordable, customized plan that lets you choose the repair facility—Plus it covers both new and used vehicles.

Take a pass on huge, unexpected repair bills. Call today for a **FREE** Quick Quote.

**877-273-9188**

Mon-Fri: 8 a.m. – 8 p.m. (Central Time)  
[www.GoodSamESP.com](http://www.GoodSamESP.com)



All program benefits are subject to the limitations set forth in the current terms and conditions. ESP is available to U.S. residents only. ESP is designed for Good Sam Club by Affinity Brokerage, LLC

fuel in 200 miles, only to arrive at a solitary service station to find a sign saying "Out of Gas" or "Out of Business." It is a familiar sight that could put you in panic mode instantly. We also recommend that you buy a spare fuel filter — just in case.

## THE GRILLE & WINDSHIELD

Protect the front of your tow vehicle with a screen or other material that will stop rocks from embedding themselves on your radiator. I rigged up a screen that kept us safe. As a bonus, a member of our caravan harvested numerous butterflies from the front to press into a framed picture, which she presented us at the end of the trip (that kind of camaraderie is a major benefit of caravanning). You can't do much about windshield dings, except to wait to return home before replacing the windshield unless it causes an unsafe driving con-

dition. Another member of our group made the whole trip without a ding, only to get smacked when driving home through Oregon.

## CLOTHING

Summers in Alaska can get very warm, but as you near glaciers, a dramatic chill sets in. Be prepared to layer on excursions. Pack a parka, raincoat and/or a waterproof jacket (although Alaska is a good place for jacket shopping) and weather-resistant boots.

## BORDER CROSSING

Check the laws to learn what Canadian Customs officers will ask you about or search for when you cross into their country. At the checkpoints the officers take their jobs very seriously, with concerns about fruit, weapons, an abundance of alcoholic beverages and other listed items.



Along with the eye-popping scenery and once-in-a-lifetime adventure, Alaska offers sometimes sporadic fuel supplies and extensive road repair.

## COVER YOUR ASSETS!!!

### AFFORDABLE AMERICAN STEEL BUILDINGS • RV COVERS •

Here it is! A Super Tough, Durable, Maintenance Free & Attractive All Steel Cover for Your RV, whether it is a Trailer or Motorhome. Protect that Investment from All Weather Conditions and Get **FREE DELIVERY & SET-UP NATIONWIDE.**



#### Affordable American Steel Buildings

- 26 yrs. in Business
- Lic. Contractor 48 States
- Meets Local Codes
- Engineer Drawings Included
- Set on the Ground or Concrete
- 20 Year Warranty
- 12 Colors
- Maintenance Free

• 4-6 Weeks Delivery

**LOWEST PRICES IN USA**



**18x31x12 - \$3,890** Most States

15' Center Height  
Use with slide outs open



STEEL GARAGES, SHEDS & BARNs  
Up to 80' Wide

CALL ME NOW

**GET THE BEST FOR LESS!**

**18x45x12 - \$4,465** Most States

15' Center Height - Use with slide outs open

**FREE DELIVERY & SET-UP NATIONWIDE**

**800-220-1973**

FOR YOUR PERSONAL QUOTE  
800-935-1939

Quotes/Questions: [www.asb1957@live.com](http://www.asb1957@live.com)  
Brochures: [AffordableSteelBuildings.biz](http://AffordableSteelBuildings.biz)

Affordable Steel Buildings, Circle 108 on Reader Service Card



An Alaskan trip is truly remarkable, especially when shared with friends. RV parks are very accommodating, but you should make reservations to ensure a spot.

**COST**

The further you drive from civilization, the higher the prices of fuel and food. You can't do much about it, so take cash or debit cards. With debit cards, however, expect to pay irritating bank service charges. Alaskan prices are slightly higher than in the Lower 48 except for fuel.

Along the way, you'll need to stop at

a bank or exchange to have Canadian currency on hand. Don't fight it! It makes going across our neighboring country much easier.

**METRIC MEASUREMENTS**

My speedometer has "kilometers per hour" on it (as I'm certain yours does),

which is the Canadian way, but I found it much too hard to read without glasses. So, I wrote the equivalents and taped them to the center of my steering wheel. It worked very well for me. Though it doesn't take long to get used to the metric system, you may want to practice a bit before you set off.

**DIRECTV for Your RV and Home!**



PACKAGES START AT JUST **\$29.99/mo** FAMILY PACKAGE

**FREE! RV KIT**

Dish, Travel Tripod & 50ft of cable\*

Offer Ends 4/30/12. FREE RV Kit for new customers only. Includes in-mounting equipment at additional charge. While supplies last. \$39.99 item will apply. Courtesy of Direct Sat TV.

**FREE! Up To 4-Room Installation\***

Additional fees apply. All DIRECTV offers require 24 month agreement.\*\*

Included at no extra charge.



Local Channels Included in every package in over 97% of the U.S.

Don't Miss Your Favorite Shows When You're on the Road!

Offer ends 4/30/12. Credit card required except in PA & TN. New approved customers only. Some required. Handling & delivery fee may apply. Applicable use for adjustment may apply to the retail value of the installation. Programming pricing may vary in certain markets.

DIRECT SAT TV An Authorized DIRECTV Dealer

You MUST Call This Toll Free! Limited Time! **800-279-3809**



\*BY SATellite KIT OFFER: Courtesy of Direct Sat TV with new residential home service activation and purchase of DIRECTV Package (Satellite) or above. Includes satellite dish, travel tripod and 50' of coaxial cable. HD Dish will incur additional fees. Tripod for HD Dish not available. Programming and pricing may vary for service in your RV. For service in RV, customer will receive 10' Direct Network Signal, based on geographical location. LA District Network is available upon request and requires special hardware, which will incur additional fees. DNS waiver required.

INSTALLATION: Standard professional home installation setup to 4 rooms only. Custom installation extra.

\*\*24-MO. LEASE AGREEMENT: EARLY CANCELLATION WILL RESULT IN A FEE OF \$20/MONTH FOR EACH REMAINING MONTH. Must maintain 24 consecutive months of your DIRECTV programming package. DTV service \$29/mo. required for DTH and HD DTH. HD Access fee \$20/mo. required for HD Receiver and HD DTH. No fees for the only 1 receiver. Lease fee for first 2 receivers \$20/mo. each. Additional receiver lease \$20/mo. each. NON-RENEWAL CHARGE OR SERVICE PROVIDED AND APPLY ALL EQUIPMENT CLEARANCE AND MUST BE RETURNED TO DIRECTV UPON CANCELLATION, OR UNLESS FINANCED EQUIPMENT (SEE APPLICABLE AGREEMENTS OR CALL 1-800-DIRECTV FOR DETAILS).

Local channels eligibility based on service address. Not all networks available in all markets. Programming, pricing, terms and conditions subject to change at any time. Pricing residential. Taxes not included. Receipt of DIRECTV programming subject to DIRECTV Customer Agreement, copy provided at directv.com/legal and in order confirmation. DIRECTV and the Stylized Design Logo, DISH and COMCAST are trademarks of DIRECTV, Inc. All other trademarks and service marks are the property of their respective owners.

Direct Satellite TV, Circle 109 on Reader Service Card

## TAKE IT EASY!

You'll quickly realize that you can't be in a rush on the way to — or once you're in — Alaska. Permafrost along much of the route causes major upheavals, which can launch you airborne before you realize you've hit it. It takes getting used to, but even after days of learning to recognize signs of upcoming frost heaves, you will still encounter a few that will send you bouncing, sometimes violently. Drive slowly to minimize trailer and tow-vehicle damage.

Most roads are paved these days. That's reassuring, but it doesn't mean you'll have smooth sailing along the way. In addition to the frost heaves on almost every highway, there is seemingly constant repair and construction that will slow you down.

## OVERNIGHT PARKING

There is a rumor that you can just park along the road at night. That is true in some places but not others. Unless you have already made reservations at a



There are plenty of scenic spots to discover; this "secret" site is one of our favorites.



LX shown with optional exterior paint package.



Spree 321RES shown in Legacy Cherry with Amaretto décor.

**Updated and Refreshed 2012 Spree**

The Spree by KZ now features a radius ceiling in select models to enhance your vacation experience.

Offering customers the best value in travel trailers is the foundation of KZ's 40-year history. Our expertise, craftsmanship and responsive service are your assurance of our commitment to your satisfaction.



[www.kz-rv.com](http://www.kz-rv.com)

KZ Inc., Circle 110 on Reader Service Card

particular RV park, plan to arrive early in the day in order to get a spot. Space is limited in most towns, so travelers do get turned away with nowhere to stop for a hundred miles. On the other hand, many park managers do try to accommodate as many travelers as possible.

## MEDICAL INFO

Get your medications before you leave. Medical facilities on the way through much of Canada's remote areas are few

and far between — and many health-insurance plans, including Medicare, don't apply. Check your plan's coverage, particularly if you have a chronic problem. Once in Alaska you will enjoy the same coverage as elsewhere in the U.S. but, of course, medical care could be 300 miles up the road.

## PETS

Don't be afraid to take your pets, but make sure you know which documents

you'll be asked for at the border crossings. Availability of pet medical care is about the same as with human facilities. One situation to think about is what happens to your pet when you head out for an 8-hour bus ride into Denali National Park or an all-day boat tour to the glaciers or fishing. There are sitter services at some RV parks for additional fees. And don't forget your pet's pills and other needs.

## COMMUNICATION

Forget cell-phone service for much of your trip up and in many areas of Alaska. Call your service carrier to find out about optional out-of-country plans and to understand availability. We have On-Star, which I expected to keep us in touch, but it, also, relies on cell towers for service.

As you travel northward, phone, Internet and satellite dish service sometimes fades away. There are Internet cafes and providers along the route, but service is not always available and, again, it can cost a bit more than in the Lower 48. Alaska does have good coverage around cities.

CB radios are often required for caravan members, who are asked to announce RV park departures and arrivals. CBs are an effective way of communicating with others in the group, be it for discussing danger along the road, where to stop for meals or simply for conversation on lonely stretches of highway.

## RESOURCES

The bible of RVing to Alaska is "The Milepost," a comprehensive guide with alternate routes and maps, as well as information about services, food, RV parks and sights practically every mile along the way. It also offers tips on what to expect on your trek into the great unknown. And, of course, membership in the Good Sam Club is a reassurance for travelers, providing reliable, customized RV-related information and services, including roadside assistance.

Set your sights on the most incredibly beautiful trip of your life, but don't go without taking the time to minimize risks. After all, it can be a bear up there. 🐻

**PERFORMANCE IN A FLASH**

**Flashpaq**

Adding performance has never been quicker or easier than Flashpaq. Get Flashpaq for your vehicle and tow with dyno-proven power. Choose from multiple tuning levels and a variety of power options including max-performance, heavy-load towing, or fuel economy\*. Flashpaq is the best-selling handheld tuner in the world for a good reason — it works!

\*Options vary by vehicle and engine configuration.

**Superchips**  
WWW.SUPERCHIPS.COM

Superchips, Circle 111 on Reader Service Card

**Bonus Offer**  
**\$50 Savings Card**



"We have had the Sleep Number bed for a few years now and can say it is the very best investment we have ever made. Back pain was a fact of life for me for years. After sleeping on the Sleep Number bed, I have improved significantly. It is amazing to go to bed in pain and wake up refreshed and pain free."

Janet D., Mt. Vernon, WA

# Better Sleep Starts with a Better Bed

## Are You Frustrated by the Quality of Your Sleep?

Do you toss and turn at night? Can't seem to find a comfortable position? Does your back ache when you awake? These are signs that your mattress may not be supporting you properly, robbing you of the sleep you need. SUFFER NO MORE!

## You Customize the Firmness

The SLEEP NUMBER® bed is unlike any other. It's the bed you adjust to your exact comfort and firmness preference, your SLEEP NUMBER® setting. Our easy-to-use handheld remote and advanced air-chamber technology allow you to quickly adjust the firmness from extra firm to feather soft at the touch of a button.

## Each Side of the Bed Adjusts Independently

Best of all, each side of the Sleep Number bed adjusts independently, making it the perfect bed for couples.

## Get Relief from Back Pain



It's the bed clinically proven to relieve back pain and improve sleep quality. Clinical studies show an amazing 93% of participants reported back-pain relief while 90% said other aches and pains were reduced.\*

\*Descriptions of clinical studies conducted on the Sleep Number bed are available at 1-800-831-1211.

†If you are not completely satisfied after sleeping on your bed for a full 30 nights, simply call us toll-free within 45 days of delivery to authorize its return. Upon receipt, we'll reimburse the full purchase price less your shipping or Home Delivery and Setup fees. You pay return shipping. There are no returns or exchanges on adjustable bases, closeout or demo bed models.

‡Restrictions apply. See card for details and expiration date.

©2009 Select Comfort



## The Sleep Number® Bed Makes Innersprings Obsolete

A traditional innerspring mattress offers only hard metal coils for support. By contrast, the Sleep Number bed's revolutionary design features air-chamber technology that adjusts to your ideal level of firmness and support.



An innerspring mattress creates uncomfortable pressure points that can disrupt sleep.

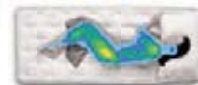

A Sleep Number® bed adjusts to your body, relieving pressure points.



## TRY IT FOR 30 NIGHTS, RISK FREE!†

We're so sure you'll sleep better, you can take up to one month to decide, or your money back!† You've got to sleep on it to believe it.



## Receive a Special Thank You Gift!

For a limited time, inquire about our revolutionary bed and we'll send you a special \$50 Savings Card to use toward the purchase of any Sleep Number bed or accessory items of \$100 or more.‡

Call Now! **1-800-831-1211** ext 76646  
sleepnumber50.com



**YES!** Please send me a FREE Brochure, DVD and Pricing.

**Limited-Time Bonus!** \$50 Thank You Savings Card!‡

Name \_\_\_\_\_  
(Please print)

Address \_\_\_\_\_

City \_\_\_\_\_ State \_\_\_\_\_ Zip \_\_\_\_\_

Daytime Phone \_\_\_\_\_ Ext. 76646

Email \_\_\_\_\_

Mail to: Sleep Number, 9800 59th Avenue N., Minneapolis, MN 55442-9807



‡Restrictions apply. See card for details and expiration date.

Select Comfort, Circle 112 on Reader Service Card

# Miles From Maru

*Not too far from this month's festivities in New Orleans, RVers can find a treasure-trove of rich history in Louisiana*

Louisiana's official nickname is "Pelican State," though it's also called "Sportsman's Paradise." My husband, Guy, and I can't exactly speak about that from personal experience — the only shooting we do is with a camera. But we've been told by folks who do know that the hunting and fishing here are excellent — and the license plates concur.

We have, however, seen some amazing critters in the state that you don't see a lot of other places in the United States outside zoos: alligators; alligator snapping turtles; snake-neck aningas; and gorgeous fuchsia-feathered roseate spoonbills, to name just a few.

Over the years Louisiana has repeatedly drawn us back, though not only for its amazing wildlife. We're also fascinat-

ed by the history, which includes some of the earliest European settlements in this part of the world. The scenery is spectacular (we're scenic-drive junkies), and of course there's the music — where else can you go on a swamp tour and watch alligators frolic while you enjoy lively Cajun tunes your guide is playing on a concertina? And last, though definitely not least, there is the food.

We're especially partial to crawfish — in gumbo, jambalaya, etouffee, meat pies and a dozen other dishes (though we haven't yet summoned the nerve to "pinch the tails and suck the heads," which locals claim is the best way to eat the tasty crustaceans).

We recently indulged several of our interests on a 135-mile scenic drive along U.S. Highway 71, which roughly

parallels the east bank of the Red River. The trip begins in Alexandria on the central-Louisiana prairie, a world of rice and sugar cane fields — along with some stout hills, a rare commodity in Louisiana. It continues to antique Natchitoches (pronounced "Nakatish"), which will celebrate its 300th anniversary in 2014, and on to lovely Shreveport, which offers several first-rate museums in addition to other attractions, but is perhaps best known as home of the old "Louisiana Hayride," where Elvis

text by **Pamela Selbert** photos by **Guy Louis Selbert**





# di Gras

Presley continued his rise to fame. We recommend allowing four or five days for the trip.

Our first Alexandria stop was at the Creole-style Kent Plantation House. Built in 1800 on a 500-acre Spanish land grant by French settler Pierre Baillio, it's the oldest standing structure in central Louisiana, said tour guide Berchmen Richard. The home, now on a four-acre site several blocks from the original location, survived the destruction of Alexandria and much of the surrounding area during the Civil War, a demolition plan a century later, and was placed on the National Register of Historic Places in 1971.

Constructed of hand-hewn cypress, handmade brick and "bousillage," a mix of clay and Spanish moss packed into the timbered walls, the restored, fully-furnished home is now the centerpiece of a 12-building complex typical of the 1795-1855 era.

Other structures include an outdoor kitchen, a reproduction 1840s sugar mill and several slave cabins erected by bricks made by some of the plantation's slaves. Kent House hosts an annual Sugar Day festival the second Saturday in November, with sugar-making demonstrations, crafts, music and fair



**The cavernous interior of the Shreveport Municipal Auditorium is rather impressive. The ornate interior of the antebellum Holy Trinity Catholic Church in Shreveport.**

food. (For information call 318-487-5998 or visit [www.kenthouse.org](http://www.kenthouse.org).)

In an area of town near the river, where the streets are made of brick with elaborate designs at the intersections, is the Arna Bontemps African American Museum and Cultural Arts Center (318-473-4692, [www.arnabontempsmuseum.org](http://www.arnabontempsmuseum.org)). The white Queen Anne revival-style house is the birthplace of Arna Wendell Bontemps, a black author, poet, scholar and pioneer in children's literature, as well as a member of the Harlem Renaissance Literary Movement. The museum has on display in the Bontemps Room, as a part of its permanent collection, the Preservation Exhibit which features several of Bontemps' literary works, family heirlooms and historic images. Bontemps dealt almost exclusively with southern African-American culture in defining his literary contributions.

Alexandria Zoological Park (318-441-

6810, [www.thealexandriazoo.com](http://www.thealexandriazoo.com)), where more than 500 animals of many species live in natural environments, is a popular attraction. Among the exhibits are Louisiana Habitat, Land of the Jaguar and African Experience. Newest zoo residents at our recent visit were a red kangaroo and a tiny golden lion tamarin.

Placards at River Park along the Red River levee tell stories of the burgundy-hued stream that begins more than 1,000 miles west and joins the Mississippi in Louisiana's Florida Parish. The first steamboat, The Enterprise, ascended the Red to Alexandria in 1814, but could go no farther because of the 160-mile long Great Raft, a mass of trees and branches so dense the river could be crossed on foot. Two decades later Captain Henry Shreve — for whom Shreveport was named — cleared the river, though the raft would continue to

**The Kansas City Southern railroad bridge across 12 Mile Bayou dates back more than 100 years.**



# HARBOR FREIGHT TOOLS

Quality Tools at Ridiculously Low Prices

**LIFETIME WARRANTY**  
ON ALL HAND TOOLS!

## FACTORY DIRECT TO YOU!

How does Harbor Freight Tools sell high quality tools at such ridiculously low prices? We buy direct from the factories who also supply the major brands and sell direct to you. It's just that simple! See for yourself at one of our 370 Stores Nationwide and use this 20% Off Coupon on one of our 7,000 products\*, plus pick up a Free 9 LED Aluminum Flashlight, a \$6.99 value. We stock Shop Equipment, Hand Tools, Tarps, Compressors, Air & Power Tools, Woodworking Tools, Welders, Tool Boxes, Generators, and much more.

- Over 20 Million Satisfied Customers!
- 1 Year Competitor's Low Price Guarantee
- No Hassle Return Policy!
- 100% Satisfaction Guaranteed!

**Nobody Beats Our Quality, Service and Price!**

**SUPER COUPON!**

**FREE!**  
WITH ANY PURCHASE

**3-1/2" SUPER BRIGHT NINE LED ALUMINUM FLASHLIGHT**

Item 65020 shown

ITEM 65020/69052/69111  
**REG. PRICE \$6.99**



**HARBOR FREIGHT TOOLS - LIMIT 1** Free item available with any purchase. Cannot be used with any other discount or coupon. Coupon not valid on prior purchases. Offer good while supplies last. Shipping & Handling charges may apply if free item not picked up in-store. Coupon cannot be bought, sold or transferred. Original coupon must be presented in-store, or with your order form, or entered online in order to receive the offer. Valid through 5/5/12. Limit one coupon per customer and one coupon per day.



**SUPER COUPON!**

**20% OFF**

ANY SINGLE ITEM!

**HARBOR FREIGHT TOOLS - LIMIT 1** Use this coupon to save 20% on any one single item purchased when you shop at a Harbor Freight Tools store. \*Cannot be used with any other discount or coupon. Coupon not valid on any of the following: gift cards, inside Track Club membership, extended service plans, Compressors, Generators, Tool Cabinets, Welders, Floor Jacks, Campbell Hausfeld products, open box items, Parking Lot Sale Items, Blowout Sale Items, Day After Thanksgiving Sale Items, Tent Sale Items, 800 number orders or online orders. Coupon not valid on prior purchases after 30 days from original purchase date with original receipt. Coupon cannot be bought, sold, or transferred. Original coupon must be presented in-store in order to receive the offer. Valid through 5/5/12. Limit one coupon per customer and one coupon per day.

Item 65020 shown



**SUPER COUPON!**

**7 FT. 4" x 9 FT. 6" ALL PURPOSE WEATHER RESISTANT TARP**

LOT NO. 877

**SAVE 50%**

**\$349** REG. PRICE \$6.99



**HARBOR FREIGHT TOOLS - LIMIT 7** This valuable coupon is good anywhere you shop Harbor Freight Tools (retail stores, online, or 800 number). Cannot be used with any other discount or coupon. Coupon not valid on prior purchases after 30 days from original purchase date with receipt. Offer good while supplies last. Coupon cannot be bought, sold, or transferred. Original coupon must be presented in-store, or with your order form, or entered online in order to receive the coupon discount. Valid through 5/5/12. Limit one coupon per customer and one coupon per day.

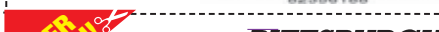

**SUPER COUPON!**

**LEATHER INDUSTRIAL WORK GLOVES - 5 PAIRS**

LOT NO. 66287

One size fits all.

**SAVE 40%**

**\$599** REG. PRICE \$9.99



**HARBOR FREIGHT TOOLS - LIMIT 9** This valuable coupon is good anywhere you shop Harbor Freight Tools (retail stores, online, or 800 number). Cannot be used with any other discount or coupon. Coupon not valid on prior purchases after 30 days from original purchase date with receipt. Offer good while supplies last. Coupon cannot be bought, sold, or transferred. Original coupon must be presented in-store, or with your order form, or entered online in order to receive the coupon discount. Valid through 5/5/12. Limit one coupon per customer and one coupon per day.



**SUPER COUPON!**

**12 VOLT MAGNETIC TOWING LIGHT KIT**

**SAVE 71%**

Item 96933 shown

**\$999** REG. PRICE \$34.99



**HARBOR FREIGHT TOOLS - LIMIT 8** This valuable coupon is good anywhere you shop Harbor Freight Tools (retail stores, online, or 800 number). Cannot be used with any other discount or coupon. Coupon not valid on prior purchases after 30 days from original purchase date with receipt. Offer good while supplies last. Coupon cannot be bought, sold, or transferred. Original coupon must be presented in-store, or with your order form, or entered online in order to receive the coupon discount. Valid through 5/5/12. Limit one coupon per customer and one coupon per day.



**SUPER COUPON!**

**105 PIECE PITTSBURGH TOOL KIT**

LOT NO. 4030

**SAVE 46%**

**\$3499** REG. PRICE \$64.99

4 DRAWER TOOL CHEST INCLUDED!



**HARBOR FREIGHT TOOLS - LIMIT 4** This valuable coupon is good anywhere you shop Harbor Freight Tools (retail stores, online, or 800 number). Cannot be used with any other discount or coupon. Coupon not valid on prior purchases after 30 days from original purchase date with receipt. Offer good while supplies last. Coupon cannot be bought, sold, or transferred. Original coupon must be presented in-store, or with your order form, or entered online in order to receive the coupon discount. Valid through 5/5/12. Limit one coupon per customer and one coupon per day.



**SUPER COUPON!**

**OSCILLATING MULTIFUNCTION POWER TOOL**

**SAVE 66%**

Item 65303 shown

**\$1999** REG. PRICE \$59.99



**HARBOR FREIGHT TOOLS - LIMIT 4** This valuable coupon is good anywhere you shop Harbor Freight Tools (retail stores, online, or 800 number). Cannot be used with any other discount or coupon. Coupon not valid on prior purchases after 30 days from original purchase date with receipt. Offer good while supplies last. Coupon cannot be bought, sold, or transferred. Original coupon must be presented in-store, or with your order form, or entered online in order to receive the coupon discount. Valid through 5/5/12. Limit one coupon per customer and one coupon per day.



**SUPER COUPON!**

**TWO BIKE HITCH MOUNT BIKE RACK**

LOT NO. 98019

**SAVE 50%**

**\$3999** REG. PRICE \$79.99



**HARBOR FREIGHT TOOLS - LIMIT 4** This valuable coupon is good anywhere you shop Harbor Freight Tools (retail stores, online, or 800 number). Cannot be used with any other discount or coupon. Coupon not valid on prior purchases after 30 days from original purchase date with receipt. Offer good while supplies last. Coupon cannot be bought, sold, or transferred. Original coupon must be presented in-store, or with your order form, or entered online in order to receive the coupon discount. Valid through 5/5/12. Limit one coupon per customer and one coupon per day.



**SUPER COUPON!**

**4 PIECE 1" x 15 FT. RATCHETING TIE DOWN SET**

LOT NO. 90984

**SAVE 52%**

**\$799** REG. PRICE \$16.99



**HARBOR FREIGHT TOOLS - LIMIT 8** This valuable coupon is good anywhere you shop Harbor Freight Tools (retail stores, online, or 800 number). Cannot be used with any other discount or coupon. Coupon not valid on prior purchases after 30 days from original purchase date with receipt. Offer good while supplies last. Coupon cannot be bought, sold, or transferred. Original coupon must be presented in-store, or with your order form, or entered online in order to receive the coupon discount. Valid through 5/5/12. Limit one coupon per customer and one coupon per day.



**SUPER COUPON!**

**MOVER'S DOLLY**

LOT NO. 93888

**SAVE 46%**

**\$799** REG. PRICE \$14.99

1000 LB. CAPACITY



**HARBOR FREIGHT TOOLS - LIMIT 9** This valuable coupon is good anywhere you shop Harbor Freight Tools (retail stores, online, or 800 number). Cannot be used with any other discount or coupon. Coupon not valid on prior purchases after 30 days from original purchase date with receipt. Offer good while supplies last. Coupon cannot be bought, sold, or transferred. Original coupon must be presented in-store, or with your order form, or entered online in order to receive the coupon discount. Valid through 5/5/12. Limit one coupon per customer and one coupon per day.

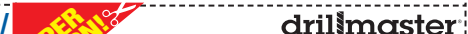

**SUPER COUPON!**

**RAPID PUMP® 3 TON HEAVY DUTY FLOOR JACK**

PITTSBURGH

**\$6499** REG. PRICE \$99.99

**WEIGHS 74 LBS.**

**SAVE \$35**

LOT NO. 68048



**HARBOR FREIGHT TOOLS - LIMIT 5** This valuable coupon is good anywhere you shop Harbor Freight Tools (retail stores, online, or 800 number). Cannot be used with any other discount or coupon. Coupon not valid on prior purchases after 30 days from original purchase date with receipt. Offer good while supplies last. Coupon cannot be bought, sold, or transferred. Original coupon must be presented in-store, or with your order form, or entered online in order to receive the coupon discount. Valid through 5/5/12. Limit one coupon per customer and one coupon per day.



**SUPER COUPON!**

**2000 WATT CONTINUOUS/ 4000 WATT PEAK POWER INVERTER**

CHICAGO POWER ELECTRIC SYSTEMS

LOT NO. 95596

Not for marine use.

**\$11999** REG. PRICE \$219.99



**HARBOR FREIGHT TOOLS - LIMIT 4** This valuable coupon is good anywhere you shop Harbor Freight Tools (retail stores, online, or 800 number). Cannot be used with any other discount or coupon. Coupon not valid on prior purchases after 30 days from original purchase date with receipt. Offer good while supplies last. Coupon cannot be bought, sold, or transferred. Original coupon must be presented in-store, or with your order form, or entered online in order to receive the coupon discount. Valid through 5/5/12. Limit one coupon per customer and one coupon per day.



**SUPER COUPON!**

**drillmaster 18 VOLT CORDLESS 3/8" DRILL/DRIVER AND FLASHLIGHT KIT**

LOT NO. 68287

**SAVE 50%**

**\$1999** REG. PRICE \$39.99

Includes one 18V NiCd battery and charger.



**HARBOR FREIGHT TOOLS - LIMIT 4** This valuable coupon is good anywhere you shop Harbor Freight Tools (retail stores, online, or 800 number). Cannot be used with any other discount or coupon. Coupon not valid on prior purchases after 30 days from original purchase date with receipt. Offer good while supplies last. Coupon cannot be bought, sold, or transferred. Original coupon must be presented in-store, or with your order form, or entered online in order to receive the coupon discount. Valid through 5/5/12. Limit one coupon per customer and one coupon per day.

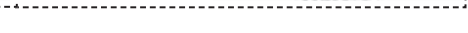

**SUPER COUPON!**

**12" RATCHET BAR CLAMP/SPREADER**  
PITTSBURGH



LOT NO. 46807/68975/69221/69222

Item 46807 shown

**SAVE 77%**

**\$199** REG. PRICE \$8.99

**HARBOR FREIGHT TOOLS - LIMIT 7**  
This valuable coupon is good anywhere you shop Harbor Freight Tools (retail stores, online, or 800 number). Cannot be used with any other discount or coupon. Coupon not valid on prior purchases after 30 days from original purchase date with receipt. Offer good while supplies last. Coupon cannot be bought, sold, or transferred. Original coupon must be presented in-store, or with your order form, or entered online in order to receive the coupon discount. Valid through 5/5/12. Limit one coupon per customer and one coupon per day.

**SUPER COUPON!**

LOT NO. 97626/68986

**80 PIECE ROTARY TOOL SET**  
CHICAGO ELECTRIC POWER TOOLS



Item 97626 shown

**SAVE 72%**

**\$699** REG. PRICE \$24.99

**HARBOR FREIGHT TOOLS - LIMIT 9**  
This valuable coupon is good anywhere you shop Harbor Freight Tools (retail stores, online, or 800 number). Cannot be used with any other discount or coupon. Coupon not valid on prior purchases after 30 days from original purchase date with receipt. Offer good while supplies last. Coupon cannot be bought, sold, or transferred. Original coupon must be presented in-store, or with your order form, or entered online in order to receive the coupon discount. Valid through 5/5/12. Limit one coupon per customer and one coupon per day.

**SUPER COUPON!**

**SOLID RUBBER WHEEL CHOCK**  
LOT NO. 96479



**SAVE 50%**

**\$499** REG. PRICE \$9.99

**HARBOR FREIGHT TOOLS - LIMIT 5**  
This valuable coupon is good anywhere you shop Harbor Freight Tools (retail stores, online, or 800 number). Cannot be used with any other discount or coupon. Coupon not valid on prior purchases after 30 days from original purchase date with receipt. Offer good while supplies last. Coupon cannot be bought, sold, or transferred. Original coupon must be presented in-store, or with your order form, or entered online in order to receive the coupon discount. Valid through 5/5/12. Limit one coupon per customer and one coupon per day.

**SUPER COUPON!**

**CENTRAL PNEUMATIC**



Item 91753 shown

LOT NO. 91753/113

**SAVE 66%**

**\$999** REG. PRICE \$29.99

**HARBOR FREIGHT TOOLS - LIMIT 8**  
This valuable coupon is good anywhere you shop Harbor Freight Tools (retail stores, online, or 800 number). Cannot be used with any other discount or coupon. Coupon not valid on prior purchases after 30 days from original purchase date with receipt. Offer good while supplies last. Coupon cannot be bought, sold, or transferred. Original coupon must be presented in-store, or with your order form, or entered online in order to receive the coupon discount. Valid through 5/5/12. Limit one coupon per customer and one coupon per day.

**SUPER COUPON!**

**CENTRALPNEUMATIC 3 GALLON, 100 PSI OILLESS PANCAKE AIR COMPRESSOR**  
LOT NO. 95275



**SAVE 46%**

**\$3999** REG. PRICE \$74.99

**HARBOR FREIGHT TOOLS - LIMIT 4**  
This valuable coupon is good anywhere you shop Harbor Freight Tools (retail stores, online, or 800 number). Cannot be used with any other discount or coupon. Coupon not valid on prior purchases after 30 days from original purchase date with receipt. Offer good while supplies last. Coupon cannot be bought, sold, or transferred. Original coupon must be presented in-store, or with your order form, or entered online in order to receive the coupon discount. Valid through 5/5/12. Limit one coupon per customer and one coupon per day.

**SUPER COUPON!**

**10/2/55 AMP, 6/12 VOLT BATTERY CHARGER/ENGINE STARTER**  
CHICAGO POWER ELECTRIC SYSTEMS  
LOT NO. 66783



**SAVE 50%**

**\$2999** REG. PRICE \$59.99

**HARBOR FREIGHT TOOLS - LIMIT 3**  
This valuable coupon is good anywhere you shop Harbor Freight Tools (retail stores, online, or 800 number). Cannot be used with any other discount or coupon. Coupon not valid on prior purchases after 30 days from original purchase date with receipt. Offer good while supplies last. Coupon cannot be bought, sold, or transferred. Original coupon must be presented in-store, or with your order form, or entered online in order to receive the coupon discount. Valid through 5/5/12. Limit one coupon per customer and one coupon per day.

**SUPER COUPON!**

**6" DIGITAL CALIPER**  
PITTSBURGH  
LOT NO. 47257



**SAVE 66%**

Includes two 1.5V button cell batteries.

**\$999** REG. PRICE \$29.99

**HARBOR FREIGHT TOOLS - LIMIT 7**  
This valuable coupon is good anywhere you shop Harbor Freight Tools (retail stores, online, or 800 number). Cannot be used with any other discount or coupon. Coupon not valid on prior purchases after 30 days from original purchase date with receipt. Offer good while supplies last. Coupon cannot be bought, sold, or transferred. Original coupon must be presented in-store, or with your order form, or entered online in order to receive the coupon discount. Valid through 5/5/12. Limit one coupon per customer and one coupon per day.

**SUPER COUPON!**

**RECIPROCATING SAW WITH ROTATING HANDLE**  
CHICAGO ELECTRIC POWER TOOLS



**SAVE 50%**

**\$1999** REG. PRICE \$39.99

LOT NO. 65570

**HARBOR FREIGHT TOOLS - LIMIT 5**  
This valuable coupon is good anywhere you shop Harbor Freight Tools (retail stores, online, or 800 number). Cannot be used with any other discount or coupon. Coupon not valid on prior purchases after 30 days from original purchase date with receipt. Offer good while supplies last. Coupon cannot be bought, sold, or transferred. Original coupon must be presented in-store, or with your order form, or entered online in order to receive the coupon discount. Valid through 5/5/12. Limit one coupon per customer and one coupon per day.

**SUPER COUPON!**

**CENTRALPNEUMATIC DUAL CHUCK TIRE INFLATOR**  
LOT NO. 68272



**SAVE 42%**

**\$399** REG. PRICE \$6.99

**HARBOR FREIGHT TOOLS - LIMIT 8**  
This valuable coupon is good anywhere you shop Harbor Freight Tools (retail stores, online, or 800 number). Cannot be used with any other discount or coupon. Coupon not valid on prior purchases after 30 days from original purchase date with receipt. Offer good while supplies last. Coupon cannot be bought, sold, or transferred. Original coupon must be presented in-store, or with your order form, or entered online in order to receive the coupon discount. Valid through 5/5/12. Limit one coupon per customer and one coupon per day.

**SUPER COUPON!**

**HaulMaster**

**500 LB. CAPACITY ALUMINUM CARGO CARRIER**  
LOT NO. 92655



**SAVE \$60**

**\$6999** REG. PRICE \$129.99

**HARBOR FREIGHT TOOLS - LIMIT 4**  
This valuable coupon is good anywhere you shop Harbor Freight Tools (retail stores, online, or 800 number). Cannot be used with any other discount or coupon. Coupon not valid on prior purchases after 30 days from original purchase date with receipt. Offer good while supplies last. Coupon cannot be bought, sold, or transferred. Original coupon must be presented in-store, or with your order form, or entered online in order to receive the coupon discount. Valid through 5/5/12. Limit one coupon per customer and one coupon per day.

**SUPER COUPON!**

**800 RATED WATTS/900 MAX. WATTS PORTABLE GENERATOR**  
CHICAGO ElectricGenerators  
LOT NO. 66619



**SAVE \$60**

**\$8999** REG. PRICE \$149.99

**HARBOR FREIGHT TOOLS - LIMIT 5**  
This valuable coupon is good anywhere you shop Harbor Freight Tools (retail stores, online, or 800 number). Cannot be used with any other discount or coupon. Coupon not valid on prior purchases after 30 days from original purchase date with receipt. Offer good while supplies last. Coupon cannot be bought, sold, or transferred. Original coupon must be presented in-store, or with your order form, or entered online in order to receive the coupon discount. Valid through 5/5/12. Limit one coupon per customer and one coupon per day.

**SUPER COUPON!**

**7 PIECE RATCHETING COMBINATION WRENCH SETS**  
PITTSBURGH



**SAVE 40%**

**YOUR CHOICE!**

**\$1799** REG. PRICE \$29.99

SAE LOT NO. 96654 | METRIC LOT NO. 95552

**HARBOR FREIGHT TOOLS - LIMIT 5**  
This valuable coupon is good anywhere you shop Harbor Freight Tools (retail stores, online, or 800 number). Cannot be used with any other discount or coupon. Coupon not valid on prior purchases after 30 days from original purchase date with receipt. Offer good while supplies last. Coupon cannot be bought, sold, or transferred. Original coupon must be presented in-store, or with your order form, or entered online in order to receive the coupon discount. Valid through 5/5/12. Limit one coupon per customer and one coupon per day.

**SUPER COUPON!**

**HaulMaster**

**30A FEMALE TO 15A MALE RV PIGTAIL POWER ADAPTER**  
LOT NO. 65942



**SAVE 50%**

**\$399** REG. PRICE \$7.99

**HARBOR FREIGHT TOOLS - LIMIT 8**  
This valuable coupon is good anywhere you shop Harbor Freight Tools (retail stores, online, or 800 number). Cannot be used with any other discount or coupon. Coupon not valid on prior purchases after 30 days from original purchase date with receipt. Offer good while supplies last. Coupon cannot be bought, sold, or transferred. Original coupon must be presented in-store, or with your order form, or entered online in order to receive the coupon discount. Valid through 5/5/12. Limit one coupon per customer and one coupon per day.

**SUPER COUPON!**

**US\*GENERAL**

**11 DRAWER ROLLER CABINET**  
LOT NO. 67421



**INCLUDES:**

- 6 Drawer Top Chest
- 2 Drawer Middle Section
- 3 Drawer Roller Cabinet

**SAVE \$150**

**\$14999** REG. PRICE \$299.99

**HARBOR FREIGHT TOOLS - LIMIT 5**  
This valuable coupon is good anywhere you shop Harbor Freight Tools (retail stores, online, or 800 number). Cannot be used with any other discount or coupon. Coupon not valid on prior purchases after 30 days from original purchase date with receipt. Offer good while supplies last. Coupon cannot be bought, sold, or transferred. Original coupon must be presented in-store, or with your order form, or entered online in order to receive the coupon discount. Valid through 5/5/12. Limit one coupon per customer and one coupon per day.

**SUPER COUPON!**

**CHICAGO POWER ELECTRIC SYSTEMS**

**45 WATT SOLAR PANEL KIT**  
LOT NO. 90599/68751



**SAVE \$80**

Item 90599 shown

**\$14999** REG. PRICE \$229.99

**HARBOR FREIGHT TOOLS - LIMIT 3**  
This valuable coupon is good anywhere you shop Harbor Freight Tools (retail stores, online, or 800 number). Cannot be used with any other discount or coupon. Coupon not valid on prior purchases after 30 days from original purchase date with receipt. Offer good while supplies last. Coupon cannot be bought, sold, or transferred. Original coupon must be presented in-store, or with your order form, or entered online in order to receive the coupon discount. Valid through 5/5/12. Limit one coupon per customer and one coupon per day.

**370 Stores Nationwide** | **Order Online at HarborFreight.com and We'll Ship Your Order FedEx.**

## Louisiana Scenic Drive

re-form.

By 1900 river transportation here had succumbed to rail competition and silting, and for nearly a century was non-existent. It was once again made possible by the Red River Waterway Project, which created a system of locks and dams dedicated between 1984 and 1992.

Across the river in Pineville, placards at Riverside Park and Forts Randolph and Buhlow State Historic Site explain the Red River Campaign of the Civil War, a Union effort to control Louisiana waterways. The heavily garrisoned forts were built by the Confederates in 1865 to repel Union attacks from the north but were never engaged, though numerous skirmishes had been fought earlier.

In 1864 the Union fleet had come to steal cotton to help fund the war effort and President Lincoln's bid for re-election. But a Confederate victory at the Battle of Mansfield left Union troops, gunboats and transport vessels stranded above the rapids near here. The campaign ended with the building of Bailey's Dam (remains were found in 1976 and placed on the National Register of Historic Places), which provided an escape and saved the fleet.

U.S. Highway 71 heads north and four lanes soon dwindle to two, but the



road is good with wide shoulders, set among rolling hills. Stands of tall pines and oaks bearded with Spanish moss alternate with fields of grass jeweled with wild flowers or cypress-studded swamp.

There are bayous, lakes and a few small towns: Montgomery, St. Maurice, Winnfield and Clarence; where the drive turns west on Louisiana Highway 6, crosses the Red into Natchitoches, the oldest town in the Louisiana Purchase. This stretch of road is part of the old El Camino Real, established more than three centuries ago and designated a National Historic Trail in 2004.

Attractions in Natchitoches, a New Orleans French Quarter look-alike, are numerous. We suggest beginning at Fort St. Jean Baptiste State Historic Site. A 13-minute film explains the area's history (settled some 1,200 years ago and first visited by Spanish explorers in the mid



Flowers bedeck the grotto behind St. Francis Xavier Cathedral in Alexandria. Begun in 1895, the first mass was celebrated here in 1899. Bald cypress stand just off highway 71.



# Casita



- Lightweight all molded fiberglass
- Self-contained and fully insulated
- Fun and easy camping

**Casita Travel Trailers**  
3030 S. McKinney • Rice Tx 75155  
Interstate 45, exit 237 or 238

**CALL TOLL FREE**  
**800-442-9986**

Casita Travel Trailers, Circle 114 on Reader Service Card



# REJEX

**Nothing Sticks but the Shine!**

Never "wax" again!  
RejeX will protect your RV better and longer than any wax-based product. Plus, it's "So Slick, Bugs Won't Stick!"

Independent tests show that RejeX can increase the life of paint, protective film and vinyl graphics by as much as 50%!

Visit [corrosionx.com](http://corrosionx.com) and save on our full line of RV cleaning kits. Use code "trailerlife" at checkout for an additional 10% savings.



**CORROSION TECHNOLOGIES**  
[corrosionx.com](http://corrosionx.com) | 800-638-7361

Corrosion Technologies, Circle 115 on Reader Service Card

# JOURNEY TO THE ENDS OF THE EARTH

*without spending your means.*



*Fig. 1 Saturn*



*Fig. 3 Asteroid Gaspra*



*Fig. 5 Mercury*



*Fig. 7 Jupiter*



*Fig. 2 Neptune*



*Fig. 4 Phases of the Moon*



*Fig. 6 Mars*

**Go Affordably. Go RVing.** Save your money for a rainy day while still enjoying a few star-filled nights. See how RVing stacks up to other modes of travel with our Vacation Cost Comparison at [GoRVing.com](http://GoRVing.com). **WHAT WILL YOU DISCOVER?**

**Go RVing.**



16th century; the French came to establish trade with the local Natchitoches Indians 150 years later). Costumed guide Tommy Adkins leads tours of the log fort, which he says was built in 1716, rebuilt using original plans 16 years later, and rebuilt yet again in 1979-81 to interpret French Colonial life. There's also a fine visitor center/museum with dioramas, maps and artifacts (318-357-3101, [www.crt.state.la.us/parks/iftstjean.aspx](http://www.crt.state.la.us/parks/iftstjean.aspx)).

No matter what you need (or think you need), you're sure to find it at Kaffie-Frederick, Louisiana's oldest general mercantile (318-352-2525, [www.oldhardwarestore.com](http://www.oldhardwarestore.com)). The 25,000-square foot store, which stocks some 80,000 items, sells everything from children's books to pipe fittings, horse shoes to reading glasses, copper weather vanes to Waterford crystal and much more.

Luke Frederick, who has owned the store since 2001, explains that brothers Harris and Adolph Kaffie, Prussian-Jewish immigrants, opened a store nearby in 1863 (it was moved to the present location in 1892). Even during the Civil War it never closed, he said. Frederick's grandfather, Titus Frederick, began working here in 1920 and bought the store 51 years later. His son, John Frederick, owned the store until 2001.

Southeast of town along the Cane River (a 36-mile long oxbow, west branch of the Red River) are some of Louisiana's finest historic plantation homes. Two are preserved as part of the 207-acre Cane River Creole National Historical Park: Oakland Plantation, a National Bicentennial Farm with 17 orig-

inal outbuildings remaining; and Magnolia Plantation Complex, 18 acres of outbuildings that include a blacksmith shop, former slave hospital and gin barn (with the only cotton press of its kind in its original site in the United States); both plantations are open for tours (318-356-8441, [www.nps.gov/cari](http://www.nps.gov/cari)). Melrose Plantation, a National Historic Landmark with a magnificent main house dating from 1833, is also open for tours (318-379-0055).

Natchitoches also includes a National Historic Landmark District, 33 blocks of antiques shops, art galleries, historic homes, restaurants and more. Carriage rides and other tours are available.

Continue north along U.S. Highway 71, passing wide fields where cattle graze and swampland where paper-white egrets stand motionless, watching for a meal to swim past. Move on to tiny Campti (which claims to be the oldest town on the Red) then Coushatta, and into Shreveport. The town of 200,000 originally called Shreve Town was founded in 1836 at the junction of the newly navigable Red River and the overland Texas Trail, said Chris Jay of the Shreveport-Bossier Convention and Tourist Bureau. During the Civil War Shreveport was capital of Louisiana (1863-1865).

Today's attractions are numerous. Our first stop was at the ornate 1929 Municipal Auditorium — where a bronze statue of "The King," Elvis Presley, stands out front, alongside a statue of his guitarist James Burton. Inside is the Stage of Stars Museum (318-220-9434).

Guide Linda Mullican explains that the "Louisiana Hayride" radio show was launched in the early 1940s as a way to get country stars to come to town, and enjoyed its heyday from 1948 to 1960. The show ended around 1963, but over the years had hosted the likes of Dolly Parton, Carl Perkins, Ernest Tubb, Ray Price, Marty Robins, Roy Rogers and Dale Evans, and many others, she said. Elvis made one of his earliest appearances here October 16, 1954. Elvis' dressing room, adorned with a glittery gold star, is on display. Louisiana Legends Gift Shop is full of artifacts: Chet Atkins' guitar, Waylon Jennings' suede jacket, a life-size cutout of Elvis in a gold lame suit, and more. Mullican said the theater, which can seat 3,000, is to be refurbished.

While beads and beer fly as the revelry continues in the southeast, RVers may wish to consider this historic and culturally rich route a more satisfying alternative during their visit to the Pelican State.

For more information on this scenic ride, including photos and restaurant suggestions, visit the Web Exclusives section at [www.trailerlife.com](http://www.trailerlife.com). 📧

**Alexandria-Pineville Area Convention & Visitors Bureau**, (800) 551-9546, [www.theheartoflouisiana.com](http://www.theheartoflouisiana.com)

**Natchitoches Area Convention & Visitors Bureau**, (800) 259-1714, [www.natchitoches.net](http://www.natchitoches.net).

**Shreveport-Bossier Convention & Tourist Bureau**, (888) 458-4748, [www.shreveport-bossier.org](http://www.shreveport-bossier.org).

## Cajun Camping

### COTILE LAKE RECREATION AREA

The recreation area includes a boat ramp, three pavilions, two playgrounds, three bathhouses, two swimming areas, fishing pier, tent sites and 66 RV sites with hook-ups, all in a lovely wooded, hilly setting. (318) 793-8995.

### NAKATOSH RV PARK AND CAMPGROUNDS

This Good Sam Park includes a recreation building, picnic tables, a bathhouse with laundry facilities, dump station and 41 RV sites with hookups. The park is adjacent to a truck stop

with a restaurant. Pets are welcome. (318) 352-0911, [www.nakatoshcamp.com](http://www.nakatoshcamp.com).

**TALL PINES RV PARK** was named one of the Top 100 Good Sam Parks 2010. The park cooperates with a pet motel (so pets need not stay alone in the RV). There's also a pool, LP-gas available, a fitness center, free Wi-fi, free cable, restroom and bathhouse, a new laundry open 24 hours, two dog parks and an excellent RV parts department. (318) 687-1010, [www.tallpinesrvpark.com](http://www.tallpinesrvpark.com).

# The Perfect Day Includes a Perfect Meal

## **efoods** DIRECT

### Gourmet Meals in 15 minutes!

- Store a Large Quantity of Food in a Small Space
- Simply Boil Water, Add Food, Simmer, Stir and Serve. Yum!
- Highly Nutritious, Retains 97% of Garden Fresh Nutrients
- Long Shelf Life - up to 25 years!
- American Grown Food Supplies

### Try 6 Meals **FREE!**

Call NOW **1-877-685-9622** or visit us online at:  
**[www.eFoodsDirect.com/RV](http://www.eFoodsDirect.com/RV)**  
for your **FREE Sample\***



Heavy Duty Totes  
are easy to store  
and easy to move.



Creamy Potato Soup

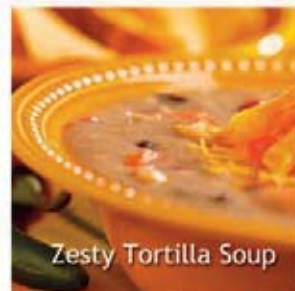

Zesty Tortilla Soup

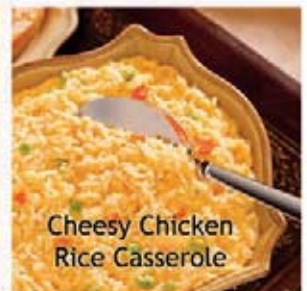

Cheesy Chicken  
Rice Casserole

\*Pay only \$9.95 for shipping and handling.

efoods Direct, Circle 116 on Reader Service Card



# LOVELAND, COLORADO

Romance, culture and wilderness — all in one place

by Irene Middleman Thomas

Just like children have been sending letters to Santa in the North Pole for decades, thousands of folks send their Valentine's Day cards to Loveland, Colorado, to be re-stamped with the Loveland postmark. Since 1946, this farming community-turned-arts center has been known as America's "Sweetheart City," due to the postal program. Loveland's annual Valentine Card program remains more than 160,000 Valentines each year.

Visitors to Loveland can find hearts all year, all over town, with the town's "Loveland: A City With HeART" project. The project's 18 individually designed and painted colossal fiberglass hearts are 5 feet tall, and almost as wide.

There's a lot more to Loveland than Valentines, including easy access to Rocky Mountain National Park and a wealth of recreational and scenic offerings, a surprising mix of artistic and cultural venues and, best of all, a wide array of RV parks to choose from. Nestled at 4,982 feet against the foothills of the Rockies, 46 miles north of Denver on the I-25 corridor, Loveland's 67,000 residents enjoy its peaceful small-town ambience mixed with big-city benefits.

Since the 1970s, artists and sculptors have flocked to the Loveland area, with is home to more than 200 unique public sculpture pieces, three major annual art shows annually and two of the nation's largest foundries. You will find evidence of these artists everywhere. Public works are creatively decorated, including large wall murals on buildings and sculpture pieces all over downtown and within two large parks.

The Benson Sculpture Gardens is home to 130 permanent outdoor sculpture pieces along with landscaped gardens and ponds, enjoyable at any time of year. Indeed, the sculptures are quite beautiful when dusted with snow. On 26 acres along the eastern side of the Promenade Shops at Centerra Mall, east of I-25, visit the fascinating Chapungu Sculpture Park at Centerra, focusing on Zimbabwean stone sculpture (Shona), with more than 80 enormous sculptures made by hand from solid rock. This peaceful, exquisitely beautiful and moving park is the largest of its kind in the world.

On the second weekend of August each year, Loveland hosts three art shows, all located around Benson

Boyd Lake State Park is a haven for waterborne activities, including skiing, rafting, kayaking and fishing. Sites at Riverview RV Park offer visitors a sense of privacy; it was voted one of the "Ten Most Romantic RV Parks in the Nation" by *MotorHome Magazine*.

PHOTOS COURTESY OF BOYD LAKE STATE PARK







PHOTO BY IRENE MIDDLEMAN THOMAS

Sculpture Garden and Lake Loveland. Sculpture in the Park, hosted by the Loveland High Plains Arts Council, is considered one of the finest outdoor juried exhibitions of three-dimensional artwork in the country, featuring sculpture from more than 200 artists from all over the world. On the grounds of Loveland High School, you can purchase art at the festive Sculpture Invitational, at the largest gathering of sculptors (more than 250) in the nation, who work in

bronze, stone, metal, glass, mixed mediums, etc., to create thousands of pieces. An arts and crafts festival, Art in the Park, is also held at this time at North Lake Park at 29th and Taft.

But Loveland has more to offer than romance and fine art. Known as “The Gateway to the Rockies,” Rocky Mountain National Park is just 30 miles west of town and is the top vacation destination in Colorado, with about 4 million visitors each year. With more than

265,000 acres of land, 178 mountain peaks over 10,000 feet in elevation, 355 miles of hiking trails and more than 140 lakes, it is truly spectacular and stunning. Visiting in early fall? Don’t miss the aspen trees’ golden glory or the elk bugling spectacle, especially awesome in neighboring Estes Park. Oh, and you can visit the Stanley Hotel here, where author Stephen King gained inspiration to write “The Shining.”

Downtown Loveland is a delightful,



# Why You **Shouldn't** Insure Your RV Like Your Car.



## Vehicle & Contents

Vehicle .....	\$25,000.00
Pack of gum.....	\$0.39
Sunglasses .....	\$12.99
Blanket .....	\$9.99
Loose change .....	\$1.27



## Vehicle & Contents

Vehicle .....	\$147,663.00
TV/DVD combo .....	\$495.99
Satellite System.....	\$999.99
Bicycles (each) .....	\$349.95

**60+ items totaling thousands of dollars**

**Your RV is *not* a car. Why insure it like one when you can have these great benefits:**

**Personal Effects Coverage** — The contents of your RV are valuable. That's why with the Good Sam Vehicle Insurance Plan, provided by GMAC Insurance, up to \$3,000 worth of your belongings are automatically insured for what you paid — not a depreciated amount! You can add more coverage if you need it.

**Storage Option** — Save money by suspending the coverage you don't need during the months your RV is not on the road. You'll still be fully protected against fire, storm, wind and theft. With only six months of our exclusive Storage Option, **you could save up to \$400!**

Big car insurance companies will sell you RV insurance, then cover your rig like a big car. But your "home away from home" deserves so much more. Good Sam VIP offers you top-of-the-line RV coverage that can save you money. RV customers who switch **save** an average of **\$349 a year!** All from the plan provided by America's RV Insurance Specialist.



**It's easy to get a fast, free quote...**

 **By phone**

Call **1-866-714-5777** and mention **Savings Code TB-Q5** to get the *best* rates.

 **Online**

Go to our website at [www.goodsamrvinsurance.com/code/Q5](http://www.goodsamrvinsurance.com/code/Q5)

Eligibility, coverages and discounts may vary. The content herein is for descriptive purposes only. The exact protection provided is subject to the terms, conditions and exceptions of the policy contract issued. Underwritten by these member companies of the GMAC Insurance Group, Winston-Salem, NC: Integon National Ins. Co., National General Assur. Co., National General Ins. Co., MIC General Ins. Corp. and GMAC Ins. Co. Online Inc. Underwritten in TX by National General Assur. Co. and National General Ins. Co. \$349 amount is based on nationwide data from new RV policyholder surveys from October 2, 2009 to March 29, 2010. RVs with an original cost new of \$500,000 or more will be insured only if all autos in household are also insured with GMAC Ins. Underwriting approval required. ©2012 GMAC Insurance. All Rights Reserved. GMAC Insurance is a registered service mark.



historic area filled with art galleries, a museum, restored theater, eclectic bistros, book stores, antique shops and lively pubs. Spend a day here in the unique non-chain shops and you're sure to find something to take home, if only some images of restored Victorian homes.

For evening entertainment, the acclaimed Candlelight Dinner Playhouse (970-744-3747, [www.coloradocandlelight.com](http://www.coloradocandlelight.com)) routinely presents well-critiqued shows along with tasty dinners over and beyond typical dinner playhouse fare. This season's lineup includes "SCROOGE! The Musical," "Anything Goes" and "Oklahoma!". You'll also find many restaurants in the downtown area, as well as in the various malls, but one that is exceptional for creative, locally grown, farm-to-table cuisine is the Rocky River Bar & Grille, inside the Embassy Suites Loveland Hotel, Spa and Conference Center off of I-25 (970-593-6200, [www.embassy-suitesloveland.com](http://www.embassy-suitesloveland.com)). Another local favorite is Biaggi's Ristorante Italiano (970-663-0100, [www.biaggis.com](http://www.biaggis.com)). Either establishment would be perfect for a special Valentine's Day meal.

#### YOU'LL LOVE IT HERE

Loveland has a wide range of choices for RVers — from right in town, to off the highway, to out in the country — but two special spots are the Boyd Lake State Campground and Riverview RV Park. Both are open year-round, but the busiest season is summertime, when you'll generally have to reserve well in advance for weekends and holidays.

Boyd Lake State Park (970-669-1739, [parks.state.co.us/Parks/Boyd-Lake](http://parks.state.co.us/Parks/Boyd-Lake)) is a water-sports enthusiasts' haven, offering boating, water-skiing, swimming, fishing and ice fishing (bass, catfish, crappie, perch, rainbow trout and walleye), windsurfing, jet skiing, and standup paddleboarding.

The lakefront RV site (Cottonwood Campground) at Boyd Lake State Park gives expansive views of the Rockies, namely of towering Long's Peak. Boyd Lake, a reservoir, covers nearly 1,700 surface acres and features two paved launch ramps. The park has a marina



FACTORY DIRECT

# HitchHiker

**Buy the best for less!**

**Purchase & Pickup from factory or dealer.  
Call or Visit [nuwa.com](http://nuwa.com) for dealer locations**

**Factory 2 hrs from three major interstates.  
Free Campground No Reservation Needed  
60 new & used TT's & 5th wheels  
Daily Factory Tours  
Low haggle near wholesale prices  
25'-40' models by NuWa, Starcraft & Rushmore**

Go to [www.nuwa.com](http://www.nuwa.com) for more information  
NuWa Industries, Chanute, KS 1.800.835.0676  
or email [sales@nuwa.com](mailto:sales@nuwa.com) with your questions.

NuWa Industries, Circle 117 on Reader Service Card

## Trailer Sway Control only DAMPENS trailer sway

**Eliminate  
trailer sway completely!**

Hensley® Towing Systems are  
**Guaranteed to  
Eliminate Trailer Sway.**

Call one of our Towing Specialists today  
and ask which Hensley® is right for you.



**Keep your family safe.**

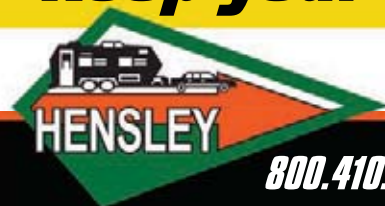

Call or visit us online **Free Video**

**800.410.6580 • [www.HensleyMfg.com](http://www.HensleyMfg.com)**

Hensley, Circle 118 on Reader Service Card

# Hit The Road With **PAY-AS- YOU-GO TV**

only from



## **TO LEARN MORE, SEE OUR DISPLAY AT THESE RV/OUTDOOR SHOWS**

New Mexico RV, Boat & Travel Show  
Colorado RV Adventure Travel Show  
Chicago RV Pavilion  
Washington Camping RV Expo  
New Jersey RV & Camping Show  
Mid-America RV Show  
Minneapolis/St. Paul RV, Vacation & Camping Show  
Richmond Camping RV Expo  
Kansas Sports, Boat & Travel Show  
North Carolina RV & Camping Show  
Atlantic City RV & Camping Show  
Colorado RV, Sports, Boat & Travel Show  
Rhode Island RV & Camping Show  
Virginia RV Show  
Summer Boat & RV Super Sale  
North Carolina Fall RV Show & Sale  
Big East Powersports Show  
Rocky Mountain Snowmobile Expo  
Atlantic City Fall RV Show  
St. Paul Ice Fishing & Winter Sports Show

For dates, times and  
more information visit:

**AffinityRVShows.com**



**Winter in the Loveland area can bring a thick, beautiful blanket of white snow.**

(summers only) with rentals of ski, pontoon and fishing boats, as well as paddle bikes and wave runners. The full-service gas dock sells ice and firewood, fishing supplies, groceries, camping supplies, etc. Some 148 paved pull-through campsites are located on a grassy meadow dotted with cottonwood trees for shade. Lakefront campsites are very desirable, so book well in advance. Camping is \$20 per night, and an annual or daily parks pass is required (annual \$70, daily \$8).

Boyd Lake connects to the Loveland Trail and Park System, so you can ride bicycles into town on the bike path. During winter, the trails are snowplowed — think snowshoeing and cross-country skiing.

Highway 34, on the way to Estes Park and Rocky Mountain National Park, is where you'll find Riverview RV Park (800-447-9910, [www.riverviewrv.com](http://www.riverviewrv.com)). Riverview, a privately owned

park, was named one of the "Ten Most Romantic RV Parks in the Nation" by *MotorHome Magazine* in 2007. With a lovely wooded setting along the rushing Big Thompson River, Riverview offers good shade trees and meandering paths affording a good level of privacy to its RVers. Dozens of wood carvings by various artisans over the last 20 years or so can be found throughout the park. The office has a scavenger hunt sheet which depicts the more notable carvings, including a raccoon, various gnomes and trolls, an owl and a bear.

There are many reasons so many RVers return, year after year, to Loveland. Whatever your reason might be for your first visit, you can count on it only being the first. Loveland is an undiscovered gem and you'll find your own special RV experience here. 📍

**Loveland Chamber of Commerce,**  
(970) 667-6311, [www.loveland.org](http://www.loveland.org).

**There's plenty to enjoy  
for visitors of all ages;  
favorites include strolls  
on the beach and  
childrens' playgrounds.**



# Don't Point the Dish Light the Grill Instead!

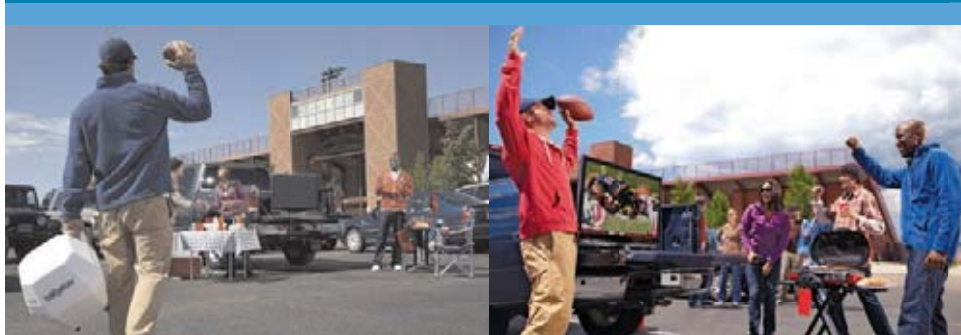

## THE TAILGATER PORTABLE HDTV SYSTEM

A revolutionary, fully-automatic portable antenna combined with a compatible DISH Network HD receiver that lets you enjoy HDTV wherever your celebration takes you.

**tailgater**  
BY DISH NETWORK™

PORTABLE HDTV SYSTEM



Enjoy the channels you love at home -- now in the great outdoors.

### How to watch satellite TV:

First, purchase the Tailgater Portable HDTV system, which includes the Tailgater antenna and a compatible mobile HD receiver (ViP 211k). Next, select your DISH Network programming package and activate your service. Visit [GoTailgater.com](http://GoTailgater.com) to order.

### Already subscribe to DISH and have a ViP 211k receiver?

If you have a ViP 211k model receiver active on your home account, all you need to do is purchase the Tailgater antenna at [GoTailgater.com](http://GoTailgater.com). You can take your ViP 211k receiver with you when you tailgate.

Requires antenna, compatible DISH Network receiver, and purchase of programming. Limit one receiver per antenna. HD programming requires HD television. Prices, packages, programming and compatible equipment subject to change without notice. All charges, including monthly programming and pay-per-view, must be paid in advance; failure to pay by due date will lead to service disconnection within 24 hours. Other restrictions may apply. Tailgater is a trademark of DISH Network L.L.C. DISH Network is a registered trademark of DISH Network L.L.C. Hardware and programming sold separately.

Dish Network, Circle 119 on Reader Service Card

Experience HDTV in  
the Great Outdoors



Stadium  
Tailgating



Backyard  
Barbecues



Camping &  
RV Road Trips

## Tailgater Features

- » Supports both HD and SD TV programming
- » Quick and easy set-up
- » No more dish-pointing
- » Automatically finds satellites
- » Lightweight for easy transportation
- » Compact to fit any space

## Pay-As-You-Go TV

Packages starting at

**\$34<sup>99</sup>**  
mo

- » Pay only for the months you use

**dish**  
NETWORK®  
AUTHORIZED RETAILER

# JUST RIGHT

text by **Stuart Bourdon**  
photos by **Rich Cox Photography**



**A**fter nearly 50 years of building RVs, Starcraft knows that change is necessary. Major overhauls, however, are not — at least when you've enjoyed five decades of success. With that in mind, Starcraft recently revamped its venerable Travel Star travel trailers by introducing a few new floorplans and really sprucing things up for 2012 with a brand-new Galaxy Package of options. From front to back, the new 299BHU Travel Star is loaded with conveniences and amenities that make it family-friendly and easy to use.

We especially like the 299BHU floorplan because of its two-door layout. A huge 30 × 72-inch main entry door offers access to the living and dining areas of the trailer. The 20-inch-wide door at the rear of the trailer provides exterior entry to the lavatory. This makes getting in and out of the bathroom easy for kids (or adults, for that matter) when they're playing

outside, as they don't have to tromp through the main room every time they need to use the facilities. The bathroom is also conveniently located adjacent to the rear bunk beds, making the frequent nighttime trips to the toilet easy for the little ones, too.

The 80 × 41-inch bunk beds offer 3-inch foam mattresses and windows with curtains at the ends of each of the two bunks. They're truly cozy spaces for the kids, or even for spare adults. The bathroom next door delivers a real china toilet with a pedal-flush system, and a bath/shower stall with plenty of room for a 6-foot, 2-inch frame to stand inside — although the top of my head was inside the skylight. A generous three-tiered linen closet is positioned in the corner between the toilet and the shower stall, while the opposite corner is filled with a cabinet and counter top with a medium-

**FAMILY-FRIENDLY STARCRAFT TRAVEL STAR  
GALAXY 299BHU IS MADE FOR SPUNKY HALF-TONS  
LIKE THE HEMI-POWERED RAM 1500 CREW CAB**



# KEYLESS ENTRY!

10-Minute Easy Install - Fits Most Trailers - Increased Security  
Replace Your Standard RV Handle with a NEW REMOTE LOCK



**ONLY \$239.99**

**RVLOCK™**  
— KEYLESS —

888.316.9899 Purchase online at [www.rvlock.com](http://www.rvlock.com)



size, but suitable, sink. A large mirrored medicine cabinet is hung above it on the wall. One of the five furnace registers in the trailer's floor is in the bathroom (the other four are in the main living/galley area), and that keeps the bathroom toasty on chilly mornings.

The living room contains a full-wall slide that makes this trailer feel voluminous inside once it's set up for camping. With the slide out, the aisle is approximately 40 inches wide, and the slide houses the business end of the galley and the overstuffed and very comfortable convertible leather sofa with a 44-inch wide seating surface.

The galley may be one of the highlights of the Galaxy option package (\$4,707), as it contains the beautiful granite-looking solid-surface counter top with the under-mounted double sink, and its cover/integrated drying rack and high-rise faucet. Also integrated into the galley is a Wedgewood Vision range and three-burner high-output stove top and oven. In between the stove and sink is a large central workspace area on the counter, while above the stove sits a HighPointe microwave. The galley is loaded with drawers and storage space above and below. Drawers stacked in the center of the lower cabinet include a top drawer split in two with the top half holding a divided silverware drawer, while the bottom half is reserved for larger items such as spatulas and trivets. A cutting board nestles nicely into the top half of the second of three drawers.

Opposite the galley and sofa is a chaise-lounge design U-shape dinette that easily seats four adults and makes an open and comfortable seating area for meals, games or conversation around a 27 x 38-inch tabletop. Two



**SECURING YOUR ENTERTAINMENT.**

**TV MOUNTS**

- ▶ Full motion
- ▶ Tilt & Swivel
- ▶ Low profile
- ▶ Base Mount
- ▶ Wall Mount
- ▶ Multiple Mounting Plate Locations





**MAKING STORAGE SIMPLE.**

**SLIDING TRAYS**

- ▶ Fully assembled
- ▶ Wide range of sizes
- ▶ Ready to install in minutes
- ▶ Cargo, Freezer, Battery, Generator, LP & Utility Trays available.



**MOR** than a suspension company. [www.morryde.com](http://www.morryde.com) 574-293-1581





The full-wall slide in the living area opens things up dramatically. The upgraded Galaxy option package offers residential-style surfaces and cabinetry. The TV works nicely for the living area, though we would have appreciated a swivel mount. The bed in the master bedroom is comfortable, provided you're 6 feet tall or shorter. The rear door offers direct access to the bathroom.

more could be seated for meals if you used picnic chairs in the extra-wide aisle. Or the dinette can be quickly converted into an 82 x 45-inch sleeping platform. We also found that the dinette offered the best view of the entertainment center and its 32-inch LCD TV and stereo/surround-sound system nestled into the wall and its cabinets that divide

the main room and the master bedroom. Next to the dinette stands the fridge/freezer. This two-door unit can easily hold enough to feed a family for a week. It is flanked and opposed by huge closets. To its rear are two large triple-tiered linen closets. Opposite the fridge and to the rear of the galley stands a huge (21 inches wide) hanging

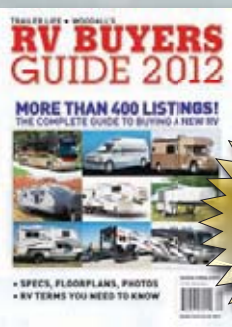

# RV Buyers Guide 2012

The largest collection of new RV models in the marketplace — all in one handy volume

**Order Now & Save!**

Completely Revised & Updated for 2012 ■ More Than 400 Listings

1-800-309-0311 ■ [www.rvb.com](http://www.rvb.com)

**ONLY \$7.99**  
plus \$2 shipping & handling

Send me a total of \_\_\_\_\_ copies of the **2012 RV Buyers Guide** for only \$7.99 plus \$2 shipping and handling per copy.

Total Payment due: \$ \_\_\_\_\_

Check or money order enclosed

Charge my:  Visa  Mastercard  Discover

Account # \_\_\_\_\_ Exp. Date \_\_\_\_\_

Signature \_\_\_\_\_

Name \_\_\_\_\_

Address \_\_\_\_\_

City \_\_\_\_\_ State \_\_\_\_\_ Zip \_\_\_\_\_

CA residents please include 50¢ sales tax. Remit U.S. funds only. Please allow 4-6 weeks for delivery.

**Clip out and mail to: 2012 RV Buyers Guide, P.O. Box 421090, Palm Coast, FL 32142**

2A65

RV Buyers Guide, Circle 199 on Reader Service Card



**BORN FREE**  
Motorcoach

**BEST BUILT COACH IN AMERICA.**  
CALL FOR FACTORY DIRECT PRICES & VIDEO  
1-866-BORNFREE • [www.bornfreemotorcoach.com](http://www.bornfreemotorcoach.com)

wardrobe, and below it a storage cabinet housing a kitchen trash can, plus a little tray behind the trash can for extra bags, gloves and other items that might be useful when dealing with the trash.

The 299BH offers a queen bed up front, which features a fat, comfy 7-inch spring mattress. But since I am 6 feet, 2 inches tall, my head and feet hit the headboard and the divider wall that houses the entertainment center when I stretch out straight on the mattress. Unfortunately, occupants of the master suite can't take advantage of the entertainment center, as the TV doesn't swivel to the opposite side. However, there is a cable TV hookup and power outlet in the rear streetside ceiling, but you would have to mount a hanger or build a custom cabinet for the TV.

The master bedroom features generous overhead cabinets and two large hanging wardrobes with nightstands on both sides of the bed. Storage space under the lift-up queen bed includes much of the exterior pass-through room, plus an additional space that includes a laundry basket hamper with its own nifty side access door to the bedroom interior. Convenient 12-volt DC lamps are located overhead for pre-slugger reading.

We noticed right away the large windows on the 299BHU that helped bring light in and make the trailer feel large inside. Another nice touch is the key hanger/corkboard note box just inside the main doorway that houses some of the master light switches and the tank and battery monitor controls inside.

On the outside, the sleek new Travel Star Galaxy package sports a gray-colored aerodynamic fiberglass front cap with integrated LED hitch lights; and a Power Package that includes an electric awning, front and rear stabilizer jacks, and an electric A-frame jack with a Fastway Flip automatic jack foot. A remote-control unit for the awning, porch light, security light, stabilizer jacks and the slideout is also part of the 23-item Galaxy option package. The front-end pass-through storage compartment features locking baggage doors with 20 x 15-inch openings and is the only exterior storage access.

The Starcraft 299BHU is designed



**TOW. MORE.**  
MORE POWER TO TOW AND MORE OF EVERYTHING ELSE.

**EDGE**

AT EDGE PRODUCTS, WE EXPECT MORE, AND SO SHOULD YOU. Edge has more product offerings, more features with more control, more accessories, and more support, with more style than anyone else in the industry. If you need more horsepower, greater torque, stronger acceleration, increased towing performance, and better fuel efficiency, we've got your Edge.

For more information call (888) 582-EDGE or visit us online at [www.edgeproducts.com/tow](http://www.edgeproducts.com/tow)

POWER CONTROL STYLE

# SOLID & DEPENDABLE



NEW - USED - REFINANCE

- Minimum Loan Amount \$20,000
- National Lender
- Financing available for:
  - Class A, B, C & Super C Motorhomes
  - Travel Trailers, 5th Wheels & Slide-in Campers
  - **Pleasure use or Full-Timer**

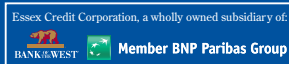

EQUAL CREDIT OPPORTUNITY LENDER

## RV Loans Made Easy!

Are you ready to take on the open road? Essex Credit wants to help you buy the perfect new or pre-owned RV. We offer competitive rates for RV purchase and refinancing. Our trusted RV sales associates provide fast, convenient, and flexible service to make the process hassle free so you can focus on finding the RV of your dreams. Visit our website to apply online, view current rates, use our payment calculator, read FAQ's, download our buyer or seller guides and much more!

[www.essexcredit.com/tl](http://www.essexcredit.com/tl)

866-377-3948



### Celebrating 31 YEARS in business!

Subject to loan program guidelines and credit approval.  
Restrictions and fees may apply. Loan programs are subject to change without notice.  
Essex, Circle 124 on Reader Service Card

## RAM SPORT CREW CAB 4X4

**MPG:** Solo: 13.4; Towing: 8.0

**ENGINE:** 5.7L V-8

**HP:** 390 @ 5,600 rpm

**TORQUE:** 407 @ 4,000 rpm

**TRANSMISSION:** 6-speed automatic

**AXLE RATIO:** 3.92:1

**FUEL CAPACITY:** 33 gal

**TIRES:** P275/60R20

**SUSPENSION:** Independent front/trailing

arm coil, solid axle rear

**BRAKES:** Four-wheel disc ABS

**TOW RATING:** 8,900 lb

**GROSS VEHICLE WEIGHT RATING:**

6,700 lb

**GROSS COMBINATION WEIGHT RATING:**

14,000 lb

**LENGTH:** 19' 1"

**WHEELBASE:** 140.5"

**MSRP, BASE:** \$39,910

**MSRP, AS TESTED:** \$51,290

**BASIC WARRANTY:** 3 yr/36,000 mi

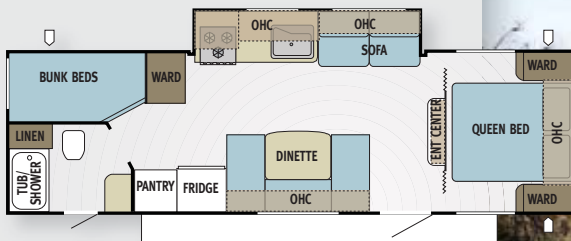

## TRAVEL STAR 299BHU

**EXT LENGTH:** 32' 7"

**EXT WIDTH:** 8'

**EXT HEIGHT:** 10' 9"

**INT HEIGHT:** 7'

**CONSTRUCTION:** Aluminum framing, vacuum-bonded laminated fiberglass side-walls and roof; unitized 1.5-inch laminated floor; one-piece seamless rubber roof; molded fiberglass front cap; bead-foam insulation.

**FRESHWATER CAP:** 62.6 gal

**BLACK-/GRAY-WATER CAP:** 32 gal/32 gal

**LP-GAS CAP:** 14 gal

**AIR CONDITIONER:** 13,500 BTU

**CONVERTER:** 45 amp

**TIRES:** ST225/75R15D

**SUSPENSION:** MOR/ryde CRE 3000 axle equalizer/springs

**WEIGHT:** (freshwater, water heater, LP-gas full; no cargo): 6,902 lb

**HITCH WEIGHT:** 665 lb

**AXLE WEIGHT:** 6,237 lb

**GROSS VEHICLE WEIGHT RATING:** 7,950 lb

**GROSS AXLE WEIGHT RATING:** (f/r):

4,400 lb/4,400 lb

**CARGO CARRYING CAPACITY:** 1,048 lb

**MSRP, BASE:** \$24,914

**MSRP, AS TESTED:** \$30,450

**BASIC WARRANTY:** 1 yr

for a half-ton truck, and the new 2012 Ram 1500 was more than up to the job. We were driving the Sport Crew Cab 4 × 4 with the 5.7-liter V-8 HEMI engine backed up by the new six-speed automatic transmission. This powerful combination moved the vehicle effortlessly through traffic on city streets or highways with no load on its tail, and showed only a moderate effort when tasked with pulling the 6,900-pound Starcraft on flat terrain.

Off-the-line launches without the trailer were aggressive as the first-gear ratio is a deep 3:1 and our test truck was equipped with the 3.92 rear axle. It wasn't until we began climbing hills with the trailer that the Ram showed any sign of a struggle. The transmission

never allowed itself to go higher than fourth gear when climbing with the trailer in tow; and by using the manual gear selection mode, we never allowed the transmission to be in any gear higher than third when descending grades with the Starcraft in order to keep our speed under control and our foot off the brake pedal the entire way down the hill.

The A-arm independent front suspension and the segment-exclusive, coil-spring, multi-link rear suspension worked wonders in helping the truck pick its way through traffic on the highway or during our in-town jaunts, and it did just as good a job helping to keep the trailer tame while following the truck around the curving mountain roads we used on our test run.



The Ram's cockpit is all truck, with straightforward controls and easy-to-read gauges. The RamBox storage bins are especially handy for tools, duffels and hunting or fishing equipment.



The Ram's fold-out towing mirrors make in-camp trailer maneuvering a breeze.

From the cockpit of the new Ram 1500, it's easy to stay in control of the vehicle and remain comfortable. The dials and instruments are easy to see and read at a glance, and the driver "infotainment" center and steering wheel buttons offer a convenient way to access and adjust systems such as the integrated electric trailer-brake controller. Our truck came with optional 10-way power (with power lumbar support) driver and six-way power adjustable passenger seats, so finding just the right spot was easy.

Backseat passengers are treated to a well-stuffed 60/40 split-folding seat with plenty of leg room even when the front seats were pushed all the way back for long-legged drivers like me. Other interior features that make a long road trip enjoyable include the premium sound system with a Sirius/AM/FM/CD/MP3 stereo and a 506-watt Alpine surround system with nine speakers and a subwoofer, dual-zone temperature control, heated and ventilated front seats, an audio jack input for mobile devices, and steering-wheel mounted audio controls.

Visibility of the truck's surroundings, especially the trailer, was excellent. Big windows and a high, commanding driver's position certainly help, but the power trailer-tow mirrors with their manual fold-out feature were a big part

of that great visibility.

Another of our favorite towing features of the Ram is the rear-view camera that comes into play when the transmission is placed in reverse. Once you get the hang of it, watching the screen while backing the truck toward the trailer's A-frame coupler in order to hook up by yourself becomes easy.

Storage capability in a pickup may seem obvious, but aside from the huge open bed, the 2012 Ram offers the Ram-Box storage bins integrated into the bed side-rails. Each Ram-Box can be used to stow gear for work or play and is weatherproof, lockable, illuminated and drainable. Storage bins with removable liners large enough to take ten 12-ounce beverages and ice can be found in the floor, and there's even more storage in compartments underneath the back seats. The cargo bed features a divider/2-foot-long bed extender, and a cargo-rail system with four sliding adjustable cleats.

Overall, we found the 2012 Ram 1500 to be a very suitable match for the Starcraft 299BHU travel trailer. Both vehicles are feature packed and deliver comfortable, enjoyable experiences. 🚚

**Ram Trucks**, [www.ramtrucks.com](http://www.ramtrucks.com).  
**Starcraft RV**, (800) 945-4787,  
[www.starcraftrv.com](http://www.starcraftrv.com). Circle 201 on  
 Reader Service Card.



## Hijacker 18K Autoslide 5th Wheel Hitch



- 14" of travel for sharper turns
- Unique jaw adjustment bolt to reduce that jerk and jolt of starting and stopping
- 3 vertical height adjustments for smoother towing experience
- 5 Year Warranty

# FULLY AUTOMATIC

*Demco*  
Since 1964

Doing Our Best to  
Provide You the Best.  
**Boyden • Iowa**

**Toll Free:  
888-421-4218**  
[www.towdemco/autoslide.com](http://www.towdemco/autoslide.com)

Dethmers Manufacturing Co., Circle 103 on Reader Service Card

# SEMA Showtime!



*The annual aftermarket product showcase brings its usual impressive array of RV-related goodies*

by Gary Wescott

As the premier automotive accessories trade show in the world, the SEMA (Specialty Equipment Market Association) Show is where new trends and hot products are unveiled. Waiting for the annual SEMA Show in Las Vegas has always been like waiting for Christmas morning; you never know what surprises you'll find under the tree — or in this case, spread out over the roughly 1 million square-feet of the Las Vegas Convention Center. Thousands of exhibitors from all over the globe come to show their newest ideas.

As we wandered the miles of tires, bumpers, lights, wheels, hitches and every automotive tool and gadget you can imagine, we were keeping an eye out for everyday functional items that could make RVing safer, more efficient and, most importantly, more fun. Always looking for better ways to tow



**Andersen Hitches  
W-D System**

our travel trailer, we were intrigued by Andersen's Silent "No-Sway" Weight Distribution system. Using chains and shock absorbers, the system eliminates the torsion bars. Andersen says it is a first in the industry, giving trailer owners the best anti-sway choice and the only true Motion-Dampening system around, with up to a 6-inch leveling capability. msrp is \$449.

**Andersen Hitches**, (800) 635-6106, [www.andersenhitches.com](http://www.andersenhitches.com). Circle 202 on Reader Service Card.



### Amp Research Power Step

The Amp Research Power Step is a slip-resistant and fully illuminated step that automatically extends when any vehicle door is opened. The step retracts when the doors are closed, folding up out of sight, without sacrificing any ground clearance. Amp Power steps feature a five-year/60,000-mile warranty and are available for a variety of applications. msrp starts at around \$1,200.

**Amp Research**, (949) 221-0023, [www.amp-research.com](http://www.amp-research.com). Circle 203 on Reader Service Card.



### DU-HA TOTE Box

On the gotta-have side, we love the new DU-HA TOTE box. Great engineering! It locks in place in a basement compartment or the back of an SUV or truck bed. It rolls like a wheel barrel. Its adjustable compartments are weather-tight, and it can be transferred to a different vehicle in seconds. Available March 1, the DU-HA TOTE has an msrp of \$299.95. An optional mounting bracket is available for \$59.95.

**DU-HA Inc.**, (866) 306-3842, [www.du-ha.com](http://www.du-ha.com). Circle 204 on Reader Service Card.

Always looking for a way to get to the bottom of things — like the underside of our truck — The Bone Mechanics Creeper is one of the best answers we've seen. Its oversized wheels will roll over cords and cracks smoothly, and the headrest

is nice, especially if you want to take a nap under your transmission. Prices start at \$114.

**The Bone Creeper**, (800) 266-3321, [www.bonecreeper.com](http://www.bonecreeper.com). Circle 205 on Reader Service Card.



The Bone Mechanics Creeper

# SEMA Showtime!

The Flag Pole Buddy solves a simple problem of where or how to fly your American flag. Most RVs have a ladder, and the Flag Pole Buddy easily clamps to the ladder's side rail. No more need to climb up. Prices start at \$94.99.

**Flag Pole Buddy**, (858) 472-5613, [www.flagpolebuddy.com](http://www.flagpolebuddy.com). Circle 206 on Reader Service Card.



**Flag Pole Buddy**



**K&N Filters**

As another step in the "green" direction, K&N Filters has introduced a new washable oil filter with what it claims is superior filtration compared to standard disposable filters. The new filters feature K&N's One Million Mile Limited Warranty, which is extremely eco-friendly, as used oil filters are a major source of pollution. msrp begins at about \$50.

**K&N Engineering Inc.**, (800) 858-3333, [www.knfilters.com](http://www.knfilters.com). Circle 207 on Reader Service Card.

Covercraft TireSavers make protecting your vehicle's tires from the sun's dam-

aging UV rays and other environmental hazards a snap. They install in seconds thanks to their exclusive spring-steel ring design, eliminating the hassle of crawling around on the ground to secure straps or bungee cords.

We also liked Covercraft's SofaSavers that will also fit couches in trailers and motorhomes. Sold in pairs, the suggested retail price starts at about \$38 per pair, price determined upon size.

**Covercraft**, (405) 238-9651, [www.covercraft.com](http://www.covercraft.com). Circle 208 on Reader Service Card.



**Covercraft SofaSaver**



**Dynatrac Hub Conversion Kit**



Also for Ram trucks, Dynatrac's Free-Spin Heavy Duty Hub Conversion Kit is now available, designed to replace the factory unit bearings with fixed spindles and serviceable bearings. Dynatrac claims its conversion kit will eliminate the failure due to the narrow bearing design and plastic bearing cages that is so often associated with unit bearings. Pricing for the new model hasn't been set, but the previous version has an msrp of \$1,989.

**Dynatrac Products Inc.,** (714) 596-4461, [www.dynatrac.com](http://www.dynatrac.com). Circle 209 on Reader Service Card.

The Banks iQ Man-Machine Interface is a Windows-based dash-mount computer for your vehicle with an interactive 5-inch color touch screen. The iQ connects to the vehicle's diagnostic port and offers vehicle information including fuel economy, tuning, performance, diagnostics and safety measures. The iQ also features audio/video entertainment features, a compass and a GPS. Shown here with the Banks SpeedBrake (not included), msrp for the iQ starts at \$585.88.

**Banks Power,** (800) 601-8072, [www.bankspower.com](http://www.bankspower.com). Circle 210 on Reader Service Card.

**Banks iQ Man-Machine Interface**



**Get Away**  
 With   
**Good Sam**

**GREAT GETAWAYS!**

**Mardi Gras Tour**  
 New Orleans, LA  
 Feb. 14-22, 2012

**Cajun Caraventure**  
 New Orleans, LA  
 March 9-22, 2012

**Autumn Leaf Caraventure**  
 Plattekill, NY  
 Sept. 27-Oct. 13, 2012

**Balloon Fiesta Tour**  
 Albuquerque, NM  
 #1: Oct. 3-9, 2012  
 #2: Oct. 9-15, 2012



**Calgary Stampede Tour**

**Calgary, Canada • July 3 - 9, 2012**

"Ya-hoo!" Nothing says rodeo like our all-new Calgary Stampede event! Join Good Sam for a view of the Canadian Rockies, enjoy reserved seats to the Calgary Stampede Parade, and experience three days of Calgary Stampede excitement including chuckwagon races, bronco, bareback and bull riding, and barrel racing just to name a few!

**MORE GETAWAYS!**

**Kobalt Tools 400 Tour**  
 Las Vegas, NV, March 8-12, 2012

**Nova Scotia Caraventure**  
 Bar Harbor, ME, July 15-28, 2012

**New York City Tour**  
 New York, NY, Sept. 23-30, 2012

**GoodSamClubRV Tours.com**  
**1-800-829-5140**

Good Sam Events, Circle 127 on Reader Service Card

# SEMA Showtime!



CargoGlide allows owners to access the contents of their pickup's bed without having to scale the bed walls or scrape their knees. Capacities range from 1,000-2,500. msrp starts at \$765.

**CargoGlide**, (239) 340-9605, [www.cargoglide.com](http://www.cargoglide.com). Circle 211 on Reader Service Card.

**CargoGlide**

Transfer Flow has completed the design of a 60-gallon replacement fuel tank for the 2011 Dodge Ram Crew Cab 8-foot-box diesel pickup, significantly increasing the fuel capacity and driving range. msrp starts at \$995.

**Transfer Flow Inc.**, (800) 442-0056, [www.transferflow.com](http://www.transferflow.com). Circle 212 on Reader Service Card.



**Transfer Flow Fuel Tank**

Spacecraft Mfg., Circle 126 on Reader Service Card



**888.463.7520**

Concordia, MO

[www.spacecraftmfg.com](http://www.spacecraftmfg.com)

Isn't it about time your trailer fit your lifestyle instead of trying to fit your lifestyle to your trailer?

Contact us today and we'll start custom building your trailer!

**It's All About You!**



You know the stuff that's always sliding across the dash in your tow vehicle? Like cell phones, ballpoint pens, loose change and the like? The Cobra Universal Anti-Slip



**Cobra Anti-Slip Pad**

Double Stick Pad magically holds all that stuff in place. The pad can be relocated as needed. No mess, glue or tools required. You can view a demo video at <http://cobrahandsfree.com/sp.html>. The anti-slip pad retails for \$9.99.

**Cobra Electronics Corporation,**  
(866) 933-0711, [cobrahandsfree.com](http://cobrahandsfree.com).  
Circle 213 on Reader Service Card.



### Golight Searchlight

Golight's search- and spotlights have been around for years, and they keep getting better. The new Golight Stryker H.I.D. features a hand-held wireless control that operates its 370° rotation and 135° tilt. The five-sided parabolic Cr5 Pentabeam can reach distances of up to a half mile away. The Stryker can be fix-mounted or use a magnetic base. The suggested retail price starts at about \$370.

**Golight,** (800) 557-0098, [www.golight.com](http://www.golight.com). Circle 214 on Reader Service Card.



### BreezeGuard Screen

BreezeGuards screens are custom-made cage metal that fit your vehicle's window opening. BreezeGuards install from the inside of the vehicle, which allows for free movement of the window glass. Single screens start at \$85 or \$160 for a pair.

**BreezeGuard,** (866) 653-5631, [www.breezeguard.net](http://www.breezeguard.net). Circle 215 on Reader Service Card.

**TICKETS ON SALE FEB. 1<sup>ST</sup>**

**MULE DAYS**

**BISHOP, CALIFORNIA • MAY 22-27, 2012**

World-Class Mule Shows • Top-Name Country Concert  
Longest Running Non-Motorized Parade in Country  
Adults-Only Dance • Western Art • Much more!  
On-Site RV Camping • Ticket Packages Available

**TELEPHONE (760) 872-4263 • MULEDAYS.ORG**

Mule Days, Circle 128 on Reader Service Card

**ADVENTURE Made Simple!**

**FREE SHIPPING** to the 48 contiguous States in US

**Now Just \$299**  
Complete with **FREE SHIPPING!**

**Our 1 or 2 Person Adventure Kayak**  
Our Sea Eagle 330 inflatable kayak makes adventure simple...simple to carry, simple to inflate, simple to paddle. Paddle wild rivers, remote ponds, scenic lakes... even ocean surf! The SE 330 packs to the size of a small duffel bag and can be carried anywhere. It is 11' 2" long, weighs just 26 lbs., holds 500 lbs. and features 2 very comfortable kayak seats, 2 skegs for easy tracking, 9 deluxe air valves for easy inflation, drain valve, super rigid I-beam floor, spray skirts & carry handles.

**SAVE \$50.** - Our SE 330 Pro Kayak Package includes 2 7' 10" aluminum paddles, 2 deluxe kayak seats, foot pump, shoulder carry bag, instructions and repair kit. Normally the Pro Package is \$349.

**NOW THIS PACKAGE IS ONLY \$299!** But that's not all, **FREE SHIPPING, 6 Month Money Back Trial Guarantee & 3 Year Warranty Against Manufacturing Defects!**

19 N. Columbia St., Port Jefferson, NY 11777

Join us on Facebook at [Facebook.com/SeaEagleBoats](https://www.facebook.com/SeaEagleBoats)

Order at [SeaEagle.com](http://SeaEagle.com)

or Call **1-800-748-8066**  
Dept **TLO12B (Mon-Fri, 9-5 EST)**

**SEA EAGLE.com**

Sea Eagle, Circle 129 on Reader Service Card



PHOTOS COURTESY OF THE MANUFACTURER

# JAYCO EAGLE 3330 RLTS

HIGHLY LIVABLE TRAVEL TRAILER ALLOWS RVERS TO SPREAD THEIR WINGS

by **Ken Freund**

**J**ayco's premium Eagle line of travel trailers is designed for long-term use and offers spacious living areas with residential-style amenities. There are four different floorplans offered in the Eagle series, with a variety of options including select model bunk rooms with sleeping accommodations for up to 10 and an outdoor kitchen.

The 3330 RLTS model featured here has three large slide-out rooms, two of which expand the living area. It's the only one of the Eagle models with slideouts on both sides of the trailer. When you walk in you truly get the feeling that you're in a house rather than an RV, as the main living area has one of the largest unencumbered floor spaces on the market. Besides the wide-open feel created by the slideouts, an 81-inch ceiling height further adds to the sense of spaciousness. Residential furniture, cushions and window treatments designed and made by Jayco add a warm feeling, and the optional LedgeStone fireplace top off the residential effect.

There are many standard, convenient features, like a convertible Dream Dinette, a comfortable sofa bed and a Carefree adjustable electric-pitch awning. Swivel rockers provide a



comfy place to watch the 32-inch LCD HDTV in the living area, which is cable- and satellite-TV prepped and has an HDTV antenna with signal booster.

Standard galley equipment includes a three-burner range with an oversized 21-inch oven. A deep double-bowl sink with sink covers and solid-surface kitchen countertops provide



The interior of the Eagle is very spacious, thanks to the triple-slide configuration. The kitchen features plenty of room for food prep, in addition to all the amenities needed to cook a meal. The walk-around queen bed and large wardrobe add to the residential feel.

ample space for food preparation, and the 8-cubic-foot double-door refrigerator holds plenty of victuals. The free-standing dinette table with four chairs offers plenty of elbow room.

Adding to the residential feel in the bathroom is a porcelain toilet and dark wood cabinetry. The seamless tub/shower surround with a glass shower door also has the look of an upscale stick home.

A large slideout provides extra width in the bedroom for the queen bed, and allows plenty of open space to walk around. The bed lifts easily on gas struts for under-bed storage, and the large wardrobe closet and chest have plenty of room for clothing and personal items.

## OUTSIDE

Standard exterior equipment includes an aerodynamic wrap-around front fiberglass cap and smooth fiberglass side walls, adding durability. The seamless one-piece rubber roof helps reduce the chance of water leaks. TuffShell vacu-

um-bonded floors, and laminated side walls, rear wall and slideouts with welded tubular aluminum framework further enhance durability.

Underneath, you'll find 15-inch radial tires stopped by Dexter Nev-R-Adjust brakes mounted on E-Z Lube axles to reduce maintenance chores. Instead of the typical steel equalizers, MOR/ryde suspension with CRE 3000 axle equalizers and rubber springs contributes to a smoother ride. The I-Class cambered structural steel I-beam frame features a one-piece design.

The unit comes with an outside shower and is prepped for an outside grill. Dual 7-gallon LP-gas cylinders and 80 gallons of fresh water capacity allow for extended camping.

Weather proofing is engineered thoughtout, with slide-out awnings, rain gutters that are molded with extended drip spouts and thermal pane tinted safety-glass windows. The water system winterization kit includes a water-heater bypass system, while

heated and enclosed freshwater and holding tanks help prevent freezing. There's reflective foil insulation in the slideout floors and roof, the baggage doors are insulated and there's a Poly Flex one-piece moisture barrier underbelly covering. The Glacier Package adds an extra layer of R-7 insulation in the roof and R-15 foil in the main floor for really cold climates.

Jayco is recognized as one of the first manufacturers to produce gold-rated products, tested by TRA Certification Inc., an independent, third-party green certifier, and the company continues to follow environmentally friendly practices. Jayco also offers an Eagle Super Lite series for folks who want to tow a lighter trailer. Whichever one you choose, you'll be getting a quality, earth-friendly product from an established company. 🚐

**Jayco Inc.**, (574) 825-5861, [www.jayco.com](http://www.jayco.com). Circle 216 on Reader Service Card.

## QUICK INFO

- EXT LENGTH: 36' 8"
- EXT WIDTH: 8'
- EXT HEIGHT: 10' 5"
- INT HEIGHT: 6' 9"
- FRESHWATER CAP: 80 gal
- BLACK-/GRAY-WATER CAP: 37 gal/ 37 gal
- LP-GAS CAP: 14 gal
- DRY HITCH WEIGHT: 1,400 lb
- GVWR: 11,250 lb
- MSRP BASE \$37,721
- MSRP, AS TESTED \$43,787

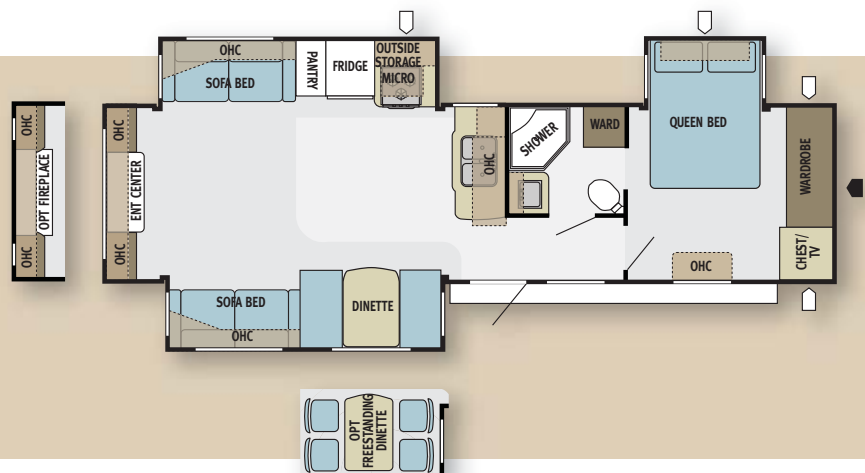



# ROCK STEADINESS

By Bob Livingston

Winfield RV Stabilizing Systems for landing and scissor jacks take the wiggle out of trailer suspensions when parked and leveled

One of the inherent aspects of living in a travel trailer or fifth-wheel is the wiggle (fore-and-aft and/or lateral movement) produced by the suspension. Landing and scissor jacks suppress much of this annoying movement, but the residual rocking sensation is disconcerting to most occupants. The simple fact remains that scissor and landing jacks still move even when planted firmly on the

ground, while the tires and springs, being flexible by design, exacerbate the problem. Winfield RV Stabilizing Systems can make your trailer feel like it's attached to a solid foundation — and the installation is very simple.

There are three components that work in concert to stabilize the frame and suspension: Landing Leg Cross Brace Stabilizers for fifth-wheels, Scissor Jack Cross Brace Stabilizers for fifth-wheels

and trailers fitted with scissor jacks and Stabilizing Wheel Chocks that shutter the rotational forces of the tires.

We installed all three systems on a fifth-wheel that suffered badly from the wiggles, even though it was equipped with the traditional front landing jacks and rear scissor jacks mounted on the corners.

The first stage of the project requires unhitching the fifth-wheel and adding the stabilizing braces to the front landing jacks. Before the bolt-on brackets could be installed, we had to determine which



It's best to bolt the front stabilizer upper brackets to the rigid square tube at the top of the landing gear (left). If you don't have 2 inches of clearance, the brackets can be installed on the leg as shown (center). Cross bars are attached to the top brackets using pins (right).



The lower brackets are attached to the bottom of the landing gear using existing holes. When the landing gear is down, the cross braces are twisted (pins with flags removed) until 2-3 inches of thread is showing at each end. Braces are twisted until holes are aligned, then pins and flags are inserted and bars hand tightened.

method could be used. The preferred method is to install the brackets on the rigid square tube at the top of the landing gear. This is the tube that's connected to the frame. If there are at least 2 inches of exposed rigid tubing, the brackets can be installed to the upper part of this housing. If not, the brackets can be installed on the upper portion of the telescoping landing gear. There's actually a third method if there is at least 1½ inches of exposed rigid tubing, which requires installing the brackets upside down and a little adjustment of the tabs to allow for cross-brace clearance.

The test fifth-wheel had plenty of housing exposed, but we used the first two methods in order to evaluate the total installation process. In both cases the brackets install easily, requiring average mechanical expertise.

Lower brackets are installed in the leg's bolt holes used to secure the footpad. The installation can't get any simpler, but care must be taken to install the brackets so that the tabs are positioned toward the rear of the landing legs to allow for cross-brace clearance. Realistically, plan on about a half hour to get all the landing-jack brackets installed.

Red flags are used as reminders to pull the pins in the cross braces before the switches are engaged to extend or retract the landing gear. Cleverly designed wheel chocks help make the trailer rock steady, although are not required to make the system work. Brackets for the rear stabilizers are mounted to the scissor jacks.

Once that's done the cross bars are pinned in place with the larger end connected to the upper bracket. The final step before the adjustment stage is to install the red warning flag over the control switches so the owner can be reminded to take proper steps when deploying and retracting the landing gear with the stabilizers in position.

The adjustment process for securing the cross braces relies on the use of locking pins with red reminder flags attached. Tightening the stabilizers is simple, requiring no tools, but the owner must be cognizant of the locking pins. Failure to use these pins properly can damage the system and void the warranty.

After the trailer is parked and leveled, the pins are strategically placed in holes in the braces after exposing 2-3 inches of thread at each end and aligning. The

braces are tensioned only by hand after the pins are relocated. To prepare for travel, the braces are loosened, the pins removed and the landing gear is retracted. The stabilizer braces follow the landing gear and are tucked up close to the frame for travel.

While the landing-gear stabilizers do a great job of steadying the front end, locking down the rear of the trailer enhances the total comfort made possible by the system. The stabilizers for the rear will adapt to most common scissor jacks. The only caveat is that the scissor jacks must be mounted at a 90-degree angle to the frame and in line with each other. Any obstructions, such as holding tanks and/or sewer pipes, must be considered before the installation can begin.

The first step is to lower the scissor jacks so they barely contact the ground





The top bracket for the scissor jack uses the existing holes. The best way to drive out the existing bolt is to use one of the bolts from the kit. The access hole is provided in the bracket to accommodate a socket. The bottom bracket bolts are tightened after confirming there are no clearance problems with the bars.

— any tension will make it difficult to remove and replace the bolts needed to attach the brackets. Once the two bolts that hold the lower assembly and jack foot are removed, the bracket can be secured using new bolts and spacers provided with the kit and then repeated on the other jack. The brackets must be installed on the left side of the jacks. For the moment, the bolts are left finger tight.

Top brackets are secured to the upper part of the scissor-jack assemblies. You might find it convenient to use a new bolt provided in the kit to drive out the existing bolt, and the bracket has a large opening to accommodate a socket for tightening the new hardware. Spacers (supplied) may be required depending on the brand of scissor jacks.

The remaining steps require sliding

the inner square tubes of the stabilizer braces into the outer tubes and then connecting to the brackets. Again, the brackets must be installed to allow for crossing of the braces. Bolts are tightened after confirming there are no clearance problems after test operating the scissor jacks. The instructions are merely adequate, but the physical installation is intuitive, which makes the process very DIY-friendly.

## Tire blow-out is the #1 worry facing RV'ers today!



And now with the Correct Track suspension alignment system, you can put those worries to rest. The primary focus of the Correct Track system is **safety**. Using our patent pending design, Correct Track bolts on to the trailer's existing spring axle hangers and properly aligns trailer suspension. Tires will now run cooler and longer, lessening the chance for tire blow-out.



Illustration of Correct Track Laser Alignment System

Through the Mobile Outfitters, dealers can take advantage of the Correct Track Laser Alignment Program. With this program, customers get a laser alignment inspection, tire tread wear measurements, air pressure check, suspension inspection and written report. All training and equipment is furnished by the Mobile Outfitters to certified Mobile Outfitters alignment dealers. Call the Mobile Outfitters today for more details at 574-312-6654.



Target Plate



Laser Alignment Tool



Correct Track II Trailer Axle Alignment Kit



With the Alignment Program, certified dealers stock the very best in suspension upgrades on the market today. The Mobile Outfitters is dedicated enhancing the mobile lifestyle. Visit us at [www.themobileoutfitters.com](http://www.themobileoutfitters.com) for more information.

Lippert Components, Circle 130 on Reader Service Card



**LOWEST**  
internet  
**PRICE**  
GUARANTEE

**RVdirect.com**  
Nothing beats direct pricing.

**WE GUARANTEE  
OUR PRICES  
TO BE THE LOWEST  
ON THE INTERNET.**

If you can find the same new RV model and features for less anywhere on the internet, we'll not only match that price but discount another \$500 when you buy from us, PERIOD!

**Laredo 266RL  
5<sup>th</sup> Wheel**



**MSRP \$37,933**  
**Your Price \$25,995**  
**You Save \$11,938**  
**\$199 Per Month**



Watch our features video

Under 8,500 Lb, dual slide outs, electric front and rear jacks, Equaflex suspension, outside speakers and much more!



**New Greyhawk  
31FK Motorhome**

**MSRP \$93,071**  
**Your Price \$66,153**  
**You Save \$26,918**  
**\$499 Per Month**



Watch our features video

Onan generator, large awning, pillow-top mattress, microwave, pass-thru storage and much more!

**New Georgetown 350TS  
Motorhome**

Full body paint, triple slide outs, 27.5" tires, Alcoa rims, dual roof air conditioning, triple stair electric entrance step and much more!



**The Lowest Prices In North America  
Delivered To Your Front Door,  
Anywhere In The World!**

**MSRP \$123,909**  
**Your Price \$86,995**  
**You Save \$36,914**  
**\$699 Per Month**



Watch our features video



**Plus, get similar savings on hundreds more!**



**800-641-7723**  
→ **www.rvdirect.com**

**RVdirect.com**  
Nothing beats direct pricing.

\*RVDirect.com prices as of 12/01/2011. All offers, plus tax, lic., reg. fees. Payments subject to lender approval. Prices are 2011 models unless otherwise noted.

RV Direct, Circle 131 on Reader Service Card



A special crank tool is used to snug the cross bars after the scissor jacks are extended. The bars are loosened so they can ride in concert with the scissor jacks and be stored close to frame (center), like the front bars (right).

A special crank tool is used to tension and loosen the braces after extending and retracting the scissor jacks respectively. As in the front, the braces snug up close to the trailer frame automatically when retracting the scissor jacks for travel mode.

The final element to make the trailer rock steady is the positioning of the company's high-end wheel chocks. A clever design allows these chocks to be configured for use between tires with spacing from 1½ to

6½ inches — accommodating virtually all narrow and wide axle set-ups using 15- and 16-inch tires. At \$79 each, these optional wheel chocks are a bit pricey, but once the user experiences how well they complement the stabilizer systems — and how easy they are to operate — the spacers will seem more than worth the money.

After all three systems were tightened to specs, the fifth-wheel was completely free of any suspension movement, and it

remained wiggle free no matter how hard we tried to push or rock the sides and rear. The end result is a whole new dimension in livability comfort.

Each cross-brace stabilizer kit adds about 20 pounds to the trailer and retails for \$199. 🚚

**Winfield RV Company**, (858) 435-0720, [www.winfieldrvproducts.com](http://www.winfieldrvproducts.com). Circle 217 on Reader Service Card.

# Adventures Begin Here

Plan your most memorable camping trip online at **Woodalls.com!**

We're updating campground listings online right now, with the latest news from our 28 rep teams in the field.

Plus, find the perfect place to stay, the best things to do, RVs for sale, dealers offering parts, service and accessories, and even find a cabin or RV to rent!

Feature articles, destination ideas, tips and checklists are updated daily at [woodalls.com](http://woodalls.com).

Also connect with us online at [blog.woodalls.com](http://blog.woodalls.com) and [facebook.com/woodalls](http://facebook.com/woodalls)

Log on to **Woodalls.com** today!





The government wears many hats. We put them all in one place.

Looking for one place to get fast answers to your questions about government benefits and services? From Social Security benefits to government jobs to tips on cutting energy costs, USA.gov has you covered. It's your official source for all federal, state and local government information. Now that's something you can hang your hat on.



1 (800) FED-INFO

A public service message from the U.S. General Services Administration.

41<sup>st</sup> Annual Syracuse RV Dealers  
Association Multi Dealer Show

NY'S LARGEST INDOOR RV SHOW  
SEE OVER 600 RV'S

# CNY RV and Camping SHOW

**MARCH 3-6, 2011 THURS 12-9, FRI & SAT 10-10, SUN 10-6**  
NYS FAIRGROUNDS 3 HUGE BUILDINGS— FULL OF 2011's,  
& THE BARGAIN BUILDING FULL OF PRE-OWNED & CLOSE-OUTS



**Checkout the  
Official Show Web Site  
[cnyRVshow.com](http://cnyRVshow.com)**

- HUNDREDS OF 2011's
- Closeouts & Pre-Owned
- Parts & Accessories
- RV Service Centers
- Campgrounds & Destinations
- Special Bank Rates
- Special RV Show Pricing

- Tent Trailers
- Travel Trailers
- Expandable Trailers
- Fifth Wheels
- Motorhomes A, B & C
- Park Trailers
- Truck Campers
- Sport Utility RV's

## CNY RV and Camping SHOW

**March 3-6, 2011**

Thur. 12-9

Fri. & Sat. 10-10

Sun 10-6

### NYS FAIRGROUNDS

Regular adult admission \$10, under 16  
free admission & free kids meal,  
must be accompanied by an adult

Name \_\_\_\_\_  
Address \_\_\_\_\_  
City \_\_\_\_\_ ST \_\_\_\_\_ Zip \_\_\_\_\_  
E-mail \_\_\_\_\_



#### FROM THE EAST

Take Rte. 90 W. to Exit 34-A  
Proceed to Rte. 481 S. to  
Rte. 690 W. to Exit 7

#### FROM THE WEST

Take Rte. 90 E. to Exit 39.  
Proceed to Rte. 690 E. to Exit 7

#### FROM THE NORTH & SOUTH

Take Rte. 81 into Syracuse to Rte 690 W to Exit 7

Print extra coupons: [cnyRVshow.com](http://cnyRVshow.com)

\*One offer/coupon per adult admission, under 16 free, not valid with any  
other offer. Regular admission \$10. Coupon may be reproduced HW

**BRING THIS COUPON FRI.-SUN.**

**SAVE—\$2.00 EA.\***

**Thursday's Bonus Day!**

**1/2 PRICED\* SHOW TICKETS**

Syracuse RV, Circle 132 on Reader Service Card

# PERFORMANCE CORNER



by Ken Freund



## SUPERCIPS VIVID PAQ TUNER

Superchips has introduced its VIVID PAQ, which uses the Android operating system to integrate popular consumer electronics features into a performance-tuning device. By combining Superchips vehicle tuning with an Internet tablet, it opens up a plethora of performance choices and features.

VIVID is designed for applications including popular diesel and gas models from Ford, GM and Dodge, and also some Jeeps and passenger cars. It can tune for heavy-load towing, fuel economy, high performance or off-road uses. By adjusting fuel delivery and timing, horsepower and torque are increased along with engine efficiency. The Android OS provides a simple user interface to make tuning easy. It syncs wirelessly with vehicles using the included Bluetooth dongle, and is 50-state emissions legal. Besides boosting power, among the many features and uses for the Superchips VIVID PAQ are gauge displays, GPS (additional antenna needed), audio, video recording and still-photo capabilities, accelerometer and inclinometer, maintenance reminders, and gaming.

Several gauge sets are available and the VIVID can intercept parameter IDs (internal OBDII codes that request data from a vehicle, used as a diagnostic tool) on the CAN bus circuitry, and display them in real time. The gauge functions provide vital information, especially when towing or off-road. You can monitor

exhaust-gas temperatures while towing, in order to avoid diesel-engine damage. This allows you to maximize performance when making settings, with real-time feedback.

With VIVID GPS capability, various topographical maps are available for off-road use. VIVID uses an onboard three-axis accelerometer with inclinometer and graphics accelerator to measure pitch and roll. This allows users to monitor performance and even off-road driving conditions.

The helpful maintenance-reminder feature helps users remember important maintenance intervals, including oil changes, tire rotation and more. The app automatically recognizes when a check engine light is on and provides a summary of what's wrong; you can then decide how urgent it is.

VIVID comes preloaded with applications for music, video and photos, and has an 8GB internal flash memory, with an SD card slot to allow for further expansion. VIVID features a built-in HD camcorder that records in 720p resolution, with HD video playback, and it has a mini HDMI output for watching video that you shoot on an auxiliary TV. You can also shoot still photos with the built-in 2 mp digital camera, and easily sync video and pictures to popular social media sites.

Let kids and friends entertain themselves on long road trips. If you want to get your game on, an onboard graphics accelerator exploits Android OS 3D capabilities for games, animated interface and transition effects. Many games utilize the three-axis accelerometer for a more realistic game playing experience. Use the HDMI output to play the game on your TV and use the device as the steering wheel or controller. Superchips, (888) 227-2447, [www.superchips.com](http://www.superchips.com). Circle 218 on Reader Service Card.

### HIGHER MPG STANDARDS FOR 2025: WHAT THEY MEAN TO YOU

According to new fuel-economy regulations set by the Environmental Protection Agency and Department of Transportation, by 2025, cars and light trucks sold in the U.S. will have to deliver a combined average city/highway rating of 54.5 mpg. By 2025, compact cars will need to meet a target of 61.1 mpg, while



*Continued on page 85 ...*

# FREE TRAVEL INFORMATION

*Trailer Life's* Free Travel Information is designed to assist RVers with their trip planning. The following destinations offer free information about their facilities and services. To request these materials, fill out the postage-paid card opposite the "Advertisers' Index" page, circle the appropriate numbers that correspond to your selections, and mail. For even faster service, visit [www.trailerlife.com/info](http://www.trailerlife.com/info) and request your information online.

## ALASKA

**Alaska and Yukon.** Get your FREE official Alaska and Yukon vacation guides today! [www.AlaskaYukon.net/TL](http://www.AlaskaYukon.net/TL). Circle 230 on Reader Service Card.

**Experience 3,500 miles of spectacular scenic waterways** in a casual atmosphere aboard an Alaska state ferry. With a vehicle or without, don't miss this unique way to see Alaska. Call (800) 642-0066, or go to [www.alaskastateferry.biz](http://www.alaskastateferry.biz). Circle 231 on Reader Service Card.

**Beyond Your Dreams. Within Your Reach.** Get your free official Alaska Travel Guide. Visit us at [www.travelalaska.com/tle](http://www.travelalaska.com/tle), or call toll-free (888) 921-8771. Circle 232 on Reader Service Card.

**Holland America Line:** Alaska and the Yukon's leading tour company with the widest selection of national parks and luxury cruises. For a free Alaska planning kit, call (877) SAIL-HAL, or visit [www.halalaska.com](http://www.halalaska.com). Circle 233 on Reader Service Card.

## ARKANSAS

**Arkansas state parks' campsites are nestled among** The Natural State's most scenic settings — atop mountains, on lakes, alongside mid-America's premier trout stream, at historic sites and a diamond site where you can search for real "finders keepers" diamonds. For free brochures, call (888) AT-PARKS, or visit [www.arkansasstateparks.com](http://www.arkansasstateparks.com). Circle 234 on Reader Service Card.

**This historic mountain resort town** is home to natural scenery, attractions, thoroughbred racing and gaming, botanical gardens, exciting theme parks and more. In America's first resort, we offer something for every age and taste in our RV-friendly city. Call (888) SPA-CITY, or visit [www.hot springs.org](http://www.hot springs.org). Circle 235 on Reader Service Card.

**Arkansas' DeGray Resort State Park** offers campsites on the shores of a 13,800-acre fishing and watersports paradise lake. Enjoy the dining at the lodge restaurant and golf at the park's championship course. Exit I-30 at Arkadelphia. Call (800) 832-8512, or visit [www.degray.com](http://www.degray.com). Circle 236 on Reader Service Card.

## CALIFORNIA

**For 55 years, the Anaheim Resort RV Park** has been providing a clean, safe and friendly RV park in Mickey's Backyard. We have Big Rig pull-thrus, a pool and jacuzzi, Free WiFi and much more. Check us out at [www.anaheimresortrvpark.com](http://www.anaheimresortrvpark.com) or call us at (714) 774-3860. Circle 237 on Reader Service Card.

**Chula Vista RV Park.** Premier RV resort with 237 spaces and a 550-slip marina settled on the south San Diego Bay with two waterfront restaurants, swimming pool, spa, fitness room, clubrooms and laundry facilities. Call (800) 770-2878, or visit the Web at [www.chulavistarv.com](http://www.chulavistarv.com). Circle 238 on Reader Service Card.

**Experience RVing,** picnicking, fishing, hiking, camping, swimming, boating and much more at Riverside County Regional Parks. For more information, call (800) 234-7275, or visit [www.riversidecountyparks.org](http://www.riversidecountyparks.org). Circle 239 on Reader Service Card.

## COLORADO

**From breathtaking natural beauty to rich history,** Colorado's got it. For trip ideas, visit [www.colorado.com](http://www.colorado.com) or call (800) COLORADO for your FREE vacation guide. Circle 240 on Reader Service Card.

## FLORIDA

**More than 120 miles of islands connected by** bridges and bounded by the Atlantic Ocean and the Gulf of Mexico. The entire Florida Keys are a designated National Marine Sanctuary. Come and enjoy the spectacular natural wonders of the Keys. Call (800) FLA-KEYS, or visit [www.fl-keys.com](http://www.fl-keys.com). Circle 241 on Reader Service Card.

## IDAHO

**Adventures for living.** Log on to [www.visitidaho.org](http://www.visitidaho.org) or call (800) VISIT-ID to order an official state travel guide and plan your trip today. Circle 242 on Reader Service Card.

**Idaho RV Campgrounds Association.** RV IDAHO! The scenery is breathtaking, outdoor recreation is legendary, and the folks are friendly. Plan to stay awhile and play in Idaho. For a free RV/campground guide, call (800) VISIT-ID, or visit [www.rvidaho.org](http://www.rvidaho.org). Circle 243 on Reader Service Card.

## MISSOURI

**FREE Missouri Vacation Planner.** For fun places and great memories, enjoy a Missouri escape! Plan yours at (800) 519-1500, ext. 89, or visit [www.visitmo.com](http://www.visitmo.com). While online, check out our valuable money-saving coupons. Circle 244 on Reader Service Card.

**Central Missouri's Lake of the Ozarks.** Beautiful 54,000-acre lake offering a breathtaking scenic panorama plus 261 holes of golf, fishing, premium outlet mall, music shows, show caves, indoor/ outdoor water parks, two state parks. Call (800) FUN-LAKE, or visit [www.funlake.com](http://www.funlake.com). Circle 245 on Reader Service Card.

## MONTANA

**Epic views bookended by** Glacier and Yellowstone national parks. Friendly locals sharing the unexpected and maybe their huckleberry pie. For your free Montana guidebook, call (800) VISIT-MT, or log on to [www.visitmt.com](http://www.visitmt.com). Circle 246 on Reader Service Card. **Visit Glacier National Park.** Satisfy your sixth sense — adventure, golf, hike, fly-fish, raft, cycle and

more. Call (800) 338-5072, or visit [www.tl.glaciermt.com](http://www.tl.glaciermt.com). Circle 247 on Reader Service Card.

## NEW MEXICO

**Located among mountains, lakes, streams,** desert lowlands and plains, New Mexico State Parks offer boundless recreation opportunities. Go fish, hike, bike, camp, climb, swim. Call (888) NM-PARKS, or visit [www.nm-parks.com](http://www.nm-parks.com). Circle 248 on Reader Service Card.

**Where unparalleled scenic beauty,** outdoor adventure, world-renowned art and cultural diversity rest under the same magical sunset. Call (800) 733-6396, ext 2863, or visit [www.newmexico.org](http://www.newmexico.org). Circle 249 on Reader Service Card.

## OHIO

**Ohio State Parks.** Discover Ohio at any of our 57 state-park campgrounds statewide. Open year-round — hiking, golf, swimming, picnicking, boating, family nature programs. Call (866) OHIO-PARKS for reservations, or visit [www.ohiostateparks.org](http://www.ohiostateparks.org). Circle 250 on Reader Service Card.

## OKLAHOMA

**Oklahoma, Native America.** Visit vibrant cities, vintage towns and world-class museums. Enjoy shopping, sightseeing, more than 200 lakes and more. Call (800) 652-6522, or visit [www.travelok.com](http://www.travelok.com) for a free travel guide. Circle 251 on Reader Service Card.

## OREGON

**Oregon State Parks.** Visit the coast, the valleys, the high desert or mountains of Oregon. At the end of an adventurous day, nestle your RV among the trees of an Oregon State Park. Call (800) 551-6949, or visit [www.oregonstateparks.org](http://www.oregonstateparks.org). Circle 252 on Reader Service Card.

## SOUTH CAROLINA

**The Santee Cooper Country** region in South Carolina surrounds lakes Marion and Moultrie. Enjoy year-round outdoor activities: world-class fishing, golf at 16 courses, boating or just relaxing. Call (800) 227-8510, or log on to [www.santeecoopercountry.org](http://www.santeecoopercountry.org). Circle 253 on Reader Service Card.

## SOUTH DAKOTA

**Come follow the Lewis and Clark Trail** for adventures and history. For more information, call (800) S-DAKOTA, or visit [www.travelsd.com](http://www.travelsd.com) to check out vacation packages. Circle 254 on Reader Service Card.

## TEXAS

**Texas State Parks** — Find out more about Texas State Parks. Call (512) 389-8900, or log on to [www.tp.state.tx.us](http://www.tp.state.tx.us). Circle 255 on Reader Service Card. 📄



# CAMPING WORLD®

## NEW YEAR KICK-OFF

SAVINGS UP TO 30%!

Prices Expire  
January 29, 2012

Supports  
up to 1000 lbs.



**CLUB SALE**  
**\$81<sup>99</sup>**  
Reg. \$91.10  
**Aluminum Folding Step #38293**  
Gripper strips on 19" x 14 1/2" platform and non-slip leg tips ensure stability. Legs lock in 2 positions for 3" or 8" step height. | 🚚 \$15



Includes handy  
side organizer  
on arm



**CLUB SALE**  
**\$31<sup>99</sup>**  
Reg. \$46.66

**Aluminum Director's Chair #42651**  
Lightweight aluminum frame. Holds 225 lbs. Weather-resistant polyester fabric. Good Sam Certified. | 🚚 \$16 | 🟢

**ELECTRIC TRIKE**

**SIT OR STAND  
TO RIDE!**



Wide removable seat

290 lb. weight  
capacity

Silver/black  
deck



Folds to 29 3/4" H x  
27 1/4" W x 41" L

**CLUB SALE**  
**\$799<sup>99</sup>**  
Reg. \$899.99

**Zappy 3 Pro-Flex Scooter #54935**  
Travel up to 17 miles at speeds up to 13 miles per hour. Just drop the handlebars and toss it in an RV storage bay. Recharges in standard 110-volt outlet. **FREIGHT \$80** | 🟢



**CLUB SALE**  
**\$8<sup>79</sup>** Reg. \$11.10  
**Porta-Pak® Tank  
Deodorizer, 10-Pack #23913**  
Ship Wt. 3/4 lb.



**HONDA**  
GENERATORS

**CLUB SALE**  
**\$999<sup>99</sup>** Reg. \$1111.10

**EU2000i CARB Compliant #34961**  
• 2000 watts max. (16.7 amps), 1600 watts rated (13.3 amps) 120-volt AC  
• 12-volt DC output 96 watts (8 amps)  
• 9.6 hours run time at 1/4 load, 4 hours at rated load  
🚚 \$30 | 🟢

🟢 Protection Plan Available

### NEW & EXPANDED CLUB!

GREAT NEWS: The President's Club & Good Sam Club have merged! Enjoy all the savings and benefits offered by Camping World to President's Club members **plus** all the discounts and benefits that the Good Sam Club members have! Visit [CampingWorld.com/GoodSam](http://CampingWorld.com/GoodSam) for details.



**Good Sam Club**

Good Friends • Good Fun • Great Savings!

Go To: **TRAILER**  
LIFE.com

User Guide

Contents

# FREE ROADTRIP GRIDDLE (#33279)

WITH PURCHASE OF ROADTRIP  
LXE GRILL (#27551)



Two porcelain-coated cast iron cooking grates

Two 10,000 BTU burners

Fold-up stand with pull handle and wheels

CLUB SALE

**\$184<sup>99</sup>**

Reg. \$211.10

RoadTrip LXE Grill #27551

Operates on 16 oz. disposable propane cylinder (sold separately). Or adapts to 20 lb. tank. Mfr. 5 year limited warranty. CSA certified. | \$30 |

# JOIN US DURING OUR NEW YEAR'S KICK-OFF CELEBRATION

Presented By

Every Friday & Saturday from  
Jan. 6th through Jan. 28th

## FREE SEMINARS!

### 10 am • GPS Navigation:

Learn how easy it is to plan and follow the best route to any destination using these electronic travel helpers.

### 12 pm • Towed Car Braking:

See how the New InvisiBrake towed car auxiliary braking system simplifies towing and driving your dinghy.

### 2 pm • Preventative Maintenance Pays:

Find out how to save time and hassles by preventing problems before they arise.

### UNADVERTISED SPECIALS

DEALS TOO GOOD TO PASS UP!

FREE SNACKS WHILE SUPPLIES LAST!

ENTER FOR A CHANCE TO WIN A \$250  
CAMPING WORLD SHOPPING SPREE!



CLUB SALE

**\$28<sup>99</sup>**

Reg. \$33.33

MAXXAIR® Roof Vent Cover,  
Translucent White #1733

Rain stays out. Mounts on vent  
sidewall. 19 1/2" L x 18 1/2" W x 9" H.  
Ship Wt. 4 lbs.

Let Us Install It—Club SALE \$16

CLUB SALE

**\$649<sup>99</sup>**

Reg. \$722.22

Winegard® Carryout® Automatic Satellite  
Antennas White #44150

Portable satellite TV antenna. Automatically  
switches between satellites. Receivers and  
program packages sold separately. | \$26 |



**NEW LOW PRICE!**

**CAMPING WORLD**

**SAVE 10%**

Annual Maintenance Package #35171.....Only \$278 Reg. \$309.99

Annual Maintenance Package with  
Generator Service #35170.....Only \$377 Reg. \$419.99

Packages include:

- LP Inspection
- Refrigerator Service
- Water Heater Service
- Exterior Inspection
- A/C Service
- Battery Service
- Generator Service  
(with package #35170)

Offer is not retroactive and cannot be used in combination with any other offer. Additional shop supplies and taxes may apply. Must present coupon at time of purchase. Expires 1/29/12. Discount Code: 2881

**CAMPING WORLD**

**SAVE 10%** on Wheel  
Bearing Packs

Single Axle #989914.....Only \$126 Reg. \$139.99

Double Axle #989915.....Only \$207 Reg. \$229.99

Triple Axle #989916.....Only \$315 Reg. \$349.99

Recommended annually to prevent bearing & brake failure

- Verify the operation of the electric brake magnets & break-away switch
- Adjust brake linings as needed
- Inspect brake shoes, bearings & magnets
- Clean & repack wheel bearings

Offer is not retroactive and cannot be used in combination with any other offer. Additional shop supplies and taxes may apply. Must present coupon at time of purchase. Expires 1/29/12. Discount Code: 2880

Camping World, Circle 138 on Reader Service Card

To request a **FREE CATALOG**, go online or call & mention code **MZ TL**

Click **CampingWorld.com** • Call **1.888.857.6590** • Come In **SuperCenters Nationwide**

Go To: **TRAILER**  
LIFE.com

User Guide

Contents



Advice from our **Tech Team**



## ROOF COATING

We have a 2003 Sunnybrook 31-foot fifth-wheel that needs to have the roof re-coated. When I've been up there, it looks light in color and is chalky to the touch. It will be my first time doing it, and I need some advice. I have looked at a lot of products and was wondering if there is an easy way to determine the best material to use. You might not be able to recommend a certain brand, but any information you can give me would be great. I won't be doing it until spring since we are going to be closing up for the year this weekend.

**David G. Shelhart**, Oregon, Ohio

*You didn't say specifically, but we're guessing your RV has a rubber roof. Given its vintage, it probably has an EPDM rubber roof, and although the material is designed to withstand years of weather abuse, it still ages. Visit your local Camping World and check the Dicor line of rubber-roof care products and you'll find a roof resealing product that applies with a paintbrush or roller. An "EPDM rubber-roofsealant" Internet search will also reveal products used by industrial suppliers, which makes sense because EPDM is a popular roofing material for large factories and the like. This material is a bit pricey, but even a few gallons are cheaper than a new roof. — Jeff Johnston*

### GOOSENECK VS. FIFTH-WHEEL

I read your piece on slider versus extension hitches in the June 2011 issue. It reminded me of a big beef I have with fifth-wheel hitches: They take up almost the entire pickup bed, either with the hitch itself (and space required for the locking arm to move) or the tongue assembly that sweeps the rear of the bed. I now realize why most cowboys use goosenecks. I'll bet you could write an entire article on such a subject and would love to read the technical discussion as to why the gooseneck is not of-

**This material is a bit pricey, but even a few gallons are cheaper than a new roof.**

fered on more RVs, the pros and cons of each system, and what are the considerations of converting a fifth-wheel to gooseneck. I sure would love the storage space.

**Granton Bartz**, Via email

*Fifth-wheel type hitches are used for RVs as the defacto standard and have been for decades. A typical fifth-wheel hitch does indeed block the middle of the bed between the wheelwells, but there's room in front and behind the hitch for storage boxes. There are numerous gooseneck-type adapters available to fit most fifth-wheel hitches on the market. Each of those adapters has full instructions about gvwr ranges, mounting options and so on. We've done several articles about those gooseneck adapters in past issues. Also, check the ads in Trailer Life and online or see your local RV accessory dealer for brand-name recommendations. — J.J.*



**Ken Freund**

**Jeff Johnston**

To send your questions to *RV Clinic*, write to 2575 Vista Del Mar, Ventura, CA 93001; or e-mail [jjohnston@affinitygroup.com](mailto:jjohnston@affinitygroup.com) or [kfreund@affinitygroup.com](mailto:kfreund@affinitygroup.com). No phone calls.

### EXCESSIVE TIRE WEAR

We've had a problem with our 2005 Forest River Cardinal travel trailer. The tires are wearing abnormally on the shoulders. Currently the front right is wearing on the outside shoulder and the rear left is wearing on the outside shoulder.

We've had the axles aligned and we are still wearing out tires. We have put about 50,000 miles on this trailer in the past seven years and bought at least four sets of tires. Do you think buying new axles will fix this problem, or is there something else we can do?

**Richard Kirkland**, Las Vegas, Nevada

*I'm curious as to what kind of "alignment" was done on your trailer. If the shop merely lined up the axles so they're parallel to each other, that's a good first step, but it doesn't address camber or toe-in misalignment. Making those adjustments calls for a shop with specialized equipment, and the knowledge to use automotive-type alignment equipment, to get your trailer rolling right.*

*If the tires are wearing on one edge the only possible cause can be misalignment. That is likely caused by bent axles, which may be caused by overloading, curb damage or potholes. The only solution for bent axles is replacement. The only other possible cause is if the axles have shifted due to loose mounting or worn or broken suspension parts, so check that carefully before replacing parts. — Ken Freund*

## READER SERVICE

### Advertisers' Index

RS #	ADVERTISERS	PAGE #
108	Affordable Steel Buildings.....	19
102	Alaska Travel Agency .....	7
107	B&W Trailer Hitches.....	17
122	Born Free Motorcoach.....	42
137	Bully Dog .....	92
114	Casita Trailers.....	28
195	Camping World.....	62,63
115	Corrosion Technologies — Rejex.....	28
103	Dethmers Manufacturing Co.....	45
109	Direct Satellite TV .....	20
119	DISH Network.....	36,37
116	eFoods Direct .....	31
123	Edge Products .....	42
	Ford Motor Company.....	2,3
124	Essex Credit .....	43
	Go RVing .....	29
	Good Sam GMAC.....	34
	Good Sam Extended Service Plan.....	18
127	Good Sam Events.....	49
	Harbor Freight Tools .....	26,27
118	Hensley.....	35
136	Hellwig Products .....	85
110	KZ Inc. ....	21
	Keystone RV Company/ GS Media.....	14
106,130	Lippert Components .....	16
121	MOR/ryde .....	40
128	Mule Days.....	51
125	Northwood Manufacturing.....	9
117	NuWa Industries .....	35
104	Progressive Insurance .....	13
133	The Rally.....	86
199	RV Buyers Guide.....	41
131	RV Direct .....	57
120	RV Locks .....	40
129	Sea Eagle .....	51
112	Select Comfort.....	23
126	Spacecraft Manufacturing.....	50
111	Superchips.....	22
132	Syracuse RV (Eastern) .....	59
	Trailer Life Directory.....	90
135	Transfer Flow .....	85
198	Woodalls.com .....	58

### Editorial Product Index

RS #	COMPANY	PAGE #
230	Alaska and Yukon .....	61
231	Alaska State Ferry .....	61
203	Amp Research .....	46
237	Anaheim Resort RV Park, CA.....	61
202	Andersen Hitches .....	46
235	Arkansas Hot Springs.....	61
234	Arkansas State Parks .....	61
210	Banks Power.....	46
205	The Bone Creeper .....	46
215	BreezeGuard .....	46
211	CargoGlide.....	46
238	Chula Vista RV Park, CA .....	61
213	Cobra Electronics Corporation.....	46
240	Colorado.com .....	61
208	Covercraft .....	46
236	DeGray Resort State Park, AR.....	61
204	DU-HA Inc.....	46
209	Dynatrac Products Inc. ....	46
206	Flag Pole Buddy .....	46
241	Florida Keys.....	61
247	Glacier National Park, MT.....	61
214	Golight .....	46
233	Holland America Line, AK .....	61
242	Idaho Adventures .....	61
243	Idaho RV Campgrounds Association.....	61
216	Jayco Inc.....	52
207	K&N Filters.....	46
245	Lake of the Ozarks, MO.....	61
248	New Mexico State Parks.....	61
249	Newmexico.org. ....	61
250	Ohio State Parks.....	61
252	Oregon State Parks .....	61
239	Riverside County Regional Parks, CA.....	61
253	Santee Cooper Country, SC.....	61
201	Starcraft RV .....	38
218	Superchips.....	60
255	Texas State Parks .....	61
212	Transfer Flow Inc. ....	46
232	Travel Alaska .....	61
251	Travel Oklahoma.....	61
254	Travel South Dakota .....	61
244	Visit Missouri.....	61
246	Visit Montana .....	61
217	Winfield RV Company.....	48

Be sure to visit  
TRAILERLIFE'S website:  
[www.trailerlife.com](http://www.trailerlife.com)



**"NO JACKKNIFING!"**



The IDAHO TOTE is attached and not drawn as a regular trailer.  
Simply put:  
**"YOU DO NOTHING BUT DRIVE!"**

- 3000 lb GVW
- Pressure sensing steering axle
- Steers traveling forward or backing up



**IDAHO TOTE DOLLY, INC.**  
[www.idahotote.com](http://www.idahotote.com)  
Call 208-276-3203 or 509-751-6297



**Heavy Duty Transmission  
Pans & Differential Covers  
Often Copied,  
Never Duplicated!**

Easier Maintenance  
No Silicone Mess  
ARP O-rings  
Sending unit  
Ready (1/8" NPT)  
A356-T6 Aluminum  
Magnetic Dipstick  
and Drain Plug!





**818.786.8325**  
[www.mag-hytec.com](http://www.mag-hytec.com)

**truckspring.com**

**TIMBREN** SUSPENSION ENHANCEMENT SYSTEM SES

Without TIMBREN SES      With TIMBREN SES



Eliminate Sag, Sway and Body Roll  
Maintenance Free - No Air Lines  
Easy to Install - No Drilling  
Increase Vehicle Stability

**Free Shipping!**



Call 1-800-358-4751 to order  
or order online at  
[www.truckspring.com](http://www.truckspring.com)

**HONDA**  
GENERATORS

**ALL NEW**  
Built-in Parallel Kit  
In Stock Now!

EU2000i & EU2000i Companion      EU3000is



Free shipping continental U.S.

Get your back-up power now!  
**Ball POWER EQUIPMENT**  
Full Line Honda Dealer  
Lightweight • Super quiet • Eco throttle • D.C. charging  
Couple 2 units together to Double output

Kansas City, MO  
(877) 225-5200 Toll Free

For optimum performance and safety, we recommend you read the owner's manual before opening your Honda Power Equipment. Connection of a generator to house power requires a transfer device to avoid possible injury to power company personnel. Consult a qualified electrician.  
©2005 American Honda Co., Inc.

**Park it with Power Caster!**

Maneuver your trailer easily in limited space, around corners, forward or reverse with the flip of a switch!



**SAFE to use:**  
✓ Chain guard  
✓ Ground wire

The Original Trailer Mover!  
Manufactured since 1957

Made in the U.S.A.  
U.S. Pat. No. 3-439-764

**POWER CASTER INC.**

(800) 773-3833  
(626) 287-6117  
[www.powercaster.com](http://www.powercaster.com)  
5001 Encinita Ave., Temple City, CA 91780

**DISH ALIGNMENT SYSTEM**  
"SEE WHAT YOUR DISH SEES"  
**ALIGN-A-SITE™** PATENT PENDING

- No Need to Level Dish Stand or Pole! Aligns Dish in ALL Directions!
- Removable Hand-Held Sighting Unit Assures Clear Line of Sight!
- Mounts Directly to ANY Dish for Accuracy!
- Also Great for INTERNET Dishes!



NOW AS LOW AS **\$119.95**

30 Day Money-Back Guarantee! (LESS S&H)

Fast, Easy Setups  
SATELLITE DISH NOT INCLUDED

[www.AlignASite.com](http://www.AlignASite.com)  
Toll Free 1-877-504-3473

Complete System \$169.95  
Sighting Unit Package \$119.95!

**Honda Generators Super Sale**

In Stock and Ready to Ship  
Honda Generator Model #EU-2000i  
**\$899**  
Free Shipping  
Model #EU-1000 \$679

Remote starter available with this generator \$239  
Honda Generator Model #EU-3000is  
**\$1,899**  
Free Shipping

Full line of Honda Generators in Stock  
• Now Available: NEW #EU-6500is, \$3,499  
Pair of EU-2000's and Parallel Cables \$1,949

Visit Us ONLINE NOW at  
[www.speedwaysales.com/Honda](http://www.speedwaysales.com/Honda)

**SPEEDWAY** sales & service

16600 W. Cleveland Ave., New Berlin, WI 53151  
**1-888-617-7333**

KEEP GOING . . . WE MIGHT MAKE IT!

**Protect your AC Unit and Satellite Dish!**

The GiraffeG4 System will tell you the exact height of the obstacle (trestle, bridge, tree, gas station canopy) before you hit it!

Relax, Enjoy Your Trip!

**GiraffeG4**  
RV OVERHEAD PROTECTION

[www.GiraffeG4.com](http://www.GiraffeG4.com)  
**1-877-543-1087**

**HONDA**  
GENERATORS

When Quiet Counts, Count on Honda



SHIPPED SAME DAY EU2000i

**LOWEST PRICES ANYWHERE!!**

800-832-7365

**MOTOSPORTS**  
OF UKIAH

1850 N. State St. Ukiah, Ca. 95482  
[www.motosportsofukiah.com](http://www.motosportsofukiah.com)

Calif. residents add 7.25%. For optimum performance and safety, we recommend you read the Owner's Manual before operating your Honda Power Equipment. Connection of generators to house power requires transfer device to avoid possible injury to power company personnel. Consult a qualified electrician.

**EXT3000**  
ELECTRIC START

- STRONG**  
3000 Watts of Power
- LIGHT**  
Weighs only 70 lbs.
- COMPACT**  
21" L x 12" W x 22" H
- POWERFUL**  
Tether 2 Units For 6000 Watts
- EFFICIENT**  
10-Hour Run Time  
Variable Throttle

Starting at \$799.99

Rec-Direct • 866-757-3780  
www.rec-direct.com/ext3000

Introducing . . . **Cupboard Corral**

Patent Pending

See us on Facebook and at Quartzsite 2012

Organize your glassware, food and medicine cabinet items and keep them in place while your coach is in motion. 14 models starting at just \$4<sup>95</sup>.

www.corralplastics.com 702-533-2407

**Parkit360**  
Power Trailer Dolly

Simple Parking For Every Trailer

1.888.926.5517  
www.parkit360.com



**RV.NET**  
Serving  
Enthusiasts of  
the Open Road  
www.rv.net

ARIZONA

VOTED "BEST IN THE NATION"



8701 S. Kolb Rd. • Tucson, Arizona 85756  
1/2 mile south of Exit 270 off I-10  
800-424-9191 • www.voyagerrv.com

100 ft. Pull-thrus ✦ Bar & Grill/Market  
WiFi Hotspots/DSL Available at Sites  
Indoor & Outdoor Pools ✦ Fitness Center  
Pickleball ✦ 9-Hole Par 3 Golf Course  
Entertainment/Activities ✦ Inn/Rental Homes

Come experience our  
southwestern hospitality



For info on  
advertising in this  
section, please  
call or write:  
Sue Seidlitz  
530-268-3005  
sseidlitz@  
goodsamfamily.com



Let The GOOD TIMES Roll.  
Just roll into any one of our 1,900 locations  
across the U.S. and Canada, and you'll find  
high quality campground and RV park  
accommodations.



**Good Sam Parks**

For more information call 800-234-3450

**If you're not  
a Good Sam  
member —  
you're losing  
money!**

You can be missing out on  
some of these great benefits:

**Discounts on:** Overnight  
camping, propane gas,  
RV parts & accessories,  
RV books & magazines.

**Low cost:** Emergency Road  
Service, vehicle and medical  
insurance plans, phone  
message service, and RV  
financing plans.

**FREE:** mail forwarding,  
trip routing, credit card  
protection, travel services  
and much more!

If you'd like more information about  
membership in the Good Sam Club

**Call toll-free  
1-800-234-3450**



# RVS FOR SALE

SELL YOUR RV ON **RVS.COM**



**USED 2006 Fleetwood FLEETWOOD POPUP** WAS \$8,285 **NOW \$3,986** SAVE \$4,299 (888) 450-7060 Dothan, AL STK #DOT39575



**NEW 2011 Jayco JAY SERIES SPORT 8** WAS \$10,115 **NOW \$6,495** SAVE \$3,620 (888) 819-7952 Longmont, CO STK #KC111526



**USED 1999 Dutchmen DUTCHMEN 427RKLSB6** WAS \$16,690 **NOW \$6,995** SAVE \$9,695 (866) 610-5049 Akron, OH STK #SRV17969



**USED 1994 Carriage CARRI-LITE** WAS \$10,958 **NOW \$6,998** SAVE \$3,960 (888) 457-4801 Colfax, NC STK #CFX4104



**USED 2001 Fleetwood PROWLER LYNX M-827-5P** **NOW \$8,995** (888) 727-2952 North Little Rock, AR STK #LIT15276



**USED 2004 Fleetwood PROWLER LYNX 829S** WAS \$22,995 **NOW \$8,995** SAVE \$14,000 (866) 754-7302 Greenwood, IN STK #GRW325508



**USED 2009 Coleman COLEMAN SARGATOGA** WAS \$15,995 **NOW \$8,995** SAVE \$7,000 (888) 682-3036 Churchville, NY STK #CHU66551



**NEW 2011 Jayco JAY SERIES 1006** WAS \$14,586 **NOW \$8,999** SAVE \$5,587 (866) 415-9726 Wheat Ridge, CO STK #KC511510



**USED 2006 Forest River PALAMINO 21FB** WAS \$17,995 **NOW \$9,495** SAVE \$8,500 (866) 754-7302 Greenwood, IN STK #GRW325770



**NEW 2011 Starcraft STARCRAFT 1020** WAS \$13,569 **NOW \$9,950** SAVE \$3,619 (866) 775-0682 Roanoke, VA STK #ROA12102



**USED 2004 Coachmen CASCADE 30TBS** WAS \$25,000 **NOW \$9,985** SAVE \$15,015 (888) 848-7312 Columbia, SC STK #COL15178



**USED 2004 Shasta CAPRI 27DS** WAS \$15,900 **NOW \$9,985** SAVE \$5,915 (866) 673-0250 Statesville, NC STK #STA125253



**USED 2001 Forest River SANDPIPER 27RKSS** **NOW \$9,995** (888) 727-2952 North Little Rock, AR STK #LIT12861



**USED 2006 Heartland BIG HORN 3105BHS** WAS \$18,999 **NOW \$9,995** SAVE \$9,004 (866) 648-5288 St. Augustine, FL STK #JAC39954



**USED 2004 Keystone LAREDO 27RK** WAS \$17,995 **NOW \$9,995** SAVE \$8,000 (888) 682-3036 Churchville, NY STK #CHU72484



**USED 2009 Coachmen SPIRIT OF AMERICA 17RD SE** WAS \$16,999 **NOW \$9,995** SAVE \$7,004 (866) 648-5288 St. Augustine, FL STK #JAC39043



**USED 2007 Coachmen SPIRIT OF AMERICA 23FKS** WAS \$19,900 **NOW \$9,999** SAVE \$9,901 (866) 289-0113 Chattanooga, TN STK #CH5713



**USED 2007 Keystone SPRINGDALE 189FL** **NOW \$10,995** (888) 331-1595 Santa Clarita, CA STK #AMRV22043 VIN #106765



**USED 2002 Keystone COUGAR 286FS** WAS \$19,995 **NOW \$10,995** SAVE \$9,000 (866) 673-0250 Statesville, NC STK #STA125166



**USED 2007 Thor FOUR WINDS LITE 28RGS** WAS \$19,847 **NOW \$10,995** SAVE \$8,852 (877) 450-7415 Island Lake, IL STK #CRV5485A



**USED 2006 Americamp AMERICAMP 30FV** WAS \$18,450 **NOW \$10,995** SAVE \$7,455 (888) 674-0275 Gulf Breeze, FL STK #GB38569



**USED 2003 Jayco KIWI 28R** **NOW \$11,292** (888) 479-3568 Vacaville, CA STK #VAC11153A VIN #JR0068



**USED 2005 Gulf Stream GULF BREEZE 23TRS** WAS \$20,000 **NOW \$11,352** SAVE \$8,648 (888) 242-0293 Madison, WI STK #MAD15088



**NEW 2010 Starcraft CENTENNIAL 3612** WAS \$17,833 **NOW \$11,495** SAVE \$6,338 (866) 502-8238 Bath, NY STK #BAT65917



**USED 2004 Fleetwood TERRY QUANTUM 300FQS** WAS \$21,995 **NOW \$11,897** SAVE \$10,098 (888) 903-6787 Harrisburg, PA STK #HAR69003



**USED 2009 Dutchmen ZOOM 718FD** **NOW \$11,900** (888) 844-1758 New Braunfels, TX STK #SWC9655



**USED 2005 Coachmen CASCADE 30TBS** WAS \$17,994 **NOW \$11,991** SAVE \$6,003 (877) 450-7415 Island Lake, IL STK #CRV5547



**USED 2002 R-Vision STRATUS S280** WAS \$25,000 **NOW \$11,995** SAVE \$13,005 (888) 860-8684 Strafford, MO STK #STR13013A



**USED 2005 Dutchmen Four Winds 29R** WAS \$17,990 **NOW \$11,995** SAVE \$5,995 (866) 673-0250 Statesville, NC STK #STA125597



**USED 2004 Forest River SANDPIPER 31RSS** WAS \$16,400 **NOW \$11,995** SAVE \$4,405 (888) 682-3036 Churchville, NY STK #CHU72480



**NEW 2011 Dutchmen FOUR WINDS 191RD** WAS \$16,090 **NOW \$11,995** SAVE \$4,095 (888) 903-6787 Harrisburg, PA STK #HAR67601



**USED 2007 K-Z SPREE 240** WAS \$15,995 **NOW \$11,995** SAVE \$4,000 (888) 819-7952 Longmont, CO STK #KC111216B



**USED 2006 Forest River FLAGSTAFF 829BHSS** WAS \$19,900 **NOW \$11,999** SAVE \$7,901 (866) 289-0113 Chattanooga, TN STK #CH6845



**USED 2006 Starcraft TRAVELSTAR 30QBS** WAS \$22,856 **NOW \$12,599** SAVE \$10,257 (888) 315-7967 Tucson, AZ STK #TUC13739



**USED 2006 Jayco JAY FLIGHT 31BHS** WAS \$25,641 **NOW \$12,900** SAVE \$12,741 (866) 996-3140 Calera, AL STK #CLE19282



**NEW 2011 Coleman COLEMAN CTS-198DB** MSRP \$19,415 **NOW \$12,900** SAVE \$6,515 (888) 844-1758 New Braunfels, TX STK #SW9617



**USED 2007 Coachmen CAPRI 300QBS** **NOW \$12,985** (888) 696-2165 Savannah, GA STK #SAV15688



**USED 2005 Coachmen SPIRIT OF AMERICA 300TBS** WAS \$26,874 **NOW \$12,995** SAVE \$13,879 (888) 242-0293 Madison, WI STK #MAD15072



**USED 2008 Dutchmen FREEDOM SPIRIT FS260** WAS \$22,998 **NOW \$12,995** SAVE \$10,003 (888) 484-3906 Spartanburg, SC STK #GR125833



**USED 2008 Keystone OUTBACK 21RSLE PT** WAS \$19,995 **NOW \$12,995** SAVE \$7,000 (866) 502-8238 Bath, NY STK #BAT66442



**USED 2002 Crossroads ALL AMERICAN 27FK** WAS \$19,476 **NOW \$12,997** SAVE \$6,479 (877) 450-7415 Island Lake, IL STK #CRV5536A



**USED 2006 Keystone ZEPPLIN Z303** WAS \$19,995 **NOW \$12,998** SAVE \$6,997 (888) 484-3906 Spartanburg, SC STK #GR125651



**USED 2006 Keystone SPRINGDALE 295** WAS \$17,988 **NOW \$13,495** SAVE \$4,493 (888) 475-5918 Robertsedale, AL STK #RD39026



**USED 2009 R-Vision TRAIL CRUISER 243S** WAS \$21,895 **NOW \$13,899** SAVE \$7,996 (866) 755-9604 Charleston, SC STK #CHN125758



**USED 2008 Starcraft ANTIGUA 215SSO** **NOW \$13,977** (888) 801-3226 Byron, GA STK #MAC15898



**NEW 2011 Coleman COLEMAN CTF340RL** LIST PRICE \$76,481 **NOW \$59,984** SAVE \$16,497 (888) 331-1595 Santa Clarita, CA STK #AMRV22005 VIN #659945



**USED 2006 Palomino THOROUGHNBRED 829RL** WAS \$30,000 **NOW \$13,995** SAVE \$16,005 (866) 775-0682 Roanoke, VA STK #ROA13381



**USED 2007 Heartland TRAIL RUNNER 3200 QB** WAS \$24,995 **NOW \$13,995** SAVE \$11,000 (866) 754-7302 Greenwood, IN STK #GRW325484



**USED 2004 Fleetwood PROWLER 295RLTS** WAS \$23,995 **NOW \$13,995** SAVE \$10,000 (866) 502-8238 Bath, NY STK #BAT66399



**USED 2006 Coachmen CAPTIVA 32** WAS \$18,497 **NOW \$13,995** SAVE \$4,502 (877) 450-7415 Island Lake, IL STK #CRV5685



**NEW 2011 Dutchmen KODIAK 177QBSL** WAS \$21,364 **NOW \$13,995** SAVE \$7,369 (866) 502-8238 Bath, NY STK #BAT66141



**USED 2006 Keystone OUTBACK SYDNEY 31RQS06** WAS \$18,690 **NOW \$13,995** SAVE \$4,695 (866) 610-5049 Akron, OH STK #SRV18320



**USED 2006 Fleetwood PROWLER 300FQS** WAS \$26,565 **NOW \$13,999** SAVE \$12,566 (888) 315-7967 Tucson, AZ STK #TUC13728



**NEW 2011 Jayco JAY FEATHER SPORT 199** MSRP \$23,338 **NOW \$14,483** SAVE \$8,855 (888) 614-5201 Draper, UT STK #ABRV36213



**NEW 2011 Jayco JAY FLIGHT 19BH** WAS \$21,993 **NOW \$14,495** SAVE \$7,498 (866) 415-9726 Wheat Ridge, CO STK #KC511367



**NEW 2011 Heartland MPG 183** WAS \$20,440 **NOW \$14,495** SAVE \$5,945 (866) 820-0335 Council Bluffs, IA STK #CBI14234



**NEW 2011 Forest River WILDWOOD 23FD** WAS \$22,995 **NOW \$14,858** SAVE \$8,137 (888) 254-9145 Meridian, ID STK #MER13998



**USED 2008 Keystone SPRINGDALE 252RD** WAS \$19,995 **NOW \$14,858** SAVE \$5,137 (888) 254-9145 Meridian, ID STK #MER15868



**USED 2007 Dutchmen ADIRONDAK 27FB-DSL** WAS \$24,329 **NOW \$14,877** SAVE \$9,452 (866) 996-3140 Calera, AL STK #CLE19283



**USED 2007 Keystone HORNET 295BH** WAS \$25,000 **NOW \$14,984** SAVE \$10,016 (888) 242-0293 Madison, WI STK #MAD15019A



**NEW 2011 Starcraft AUTUMN RIDGE 186BH** WAS \$19,727 **NOW \$14,987** SAVE \$4,740 (888) 692-9016 Myrtle Beach, SC STK #MB124375



**USED 2008 Crossroads ZINGER 26BH** **NOW \$14,995** (888) 668-6715 Katy, TX STK #KAT9874



**USED 2007 Forest River WILDWOOD 282RLSS** **NOW \$14,995** (888) 905-0490 Anthony, TX STK #LC15375C





**USED 2005 Four Winds FOUR WINDS 38KE** WAS \$25,000 **NOW \$14,995** SAVE \$10,005 (888) 848-7312 Columbia, SC STK #COL15139



**NEW 2011 Keystone PASSPORT 199ML** WAS \$24,545 **NOW \$14,995** SAVE \$9,550 (866) 610-5049 Akron, OH STK #SRV18048



**USED 2004 Sunnybrook SUNNYBROOK 30FKS** WAS \$24,334 **NOW \$14,995** SAVE \$9,339 (888) 860-8684 Strafford, MO STK #STR8861B



**NEW 2011 Heartland MPG T185** WAS \$22,467 **NOW \$14,995** SAVE \$7,472 (866) 820-0335 Council Bluffs, IA STK #CBI14235



**NEW 2011 Keystone BULLET 188EXP** WAS \$21,947 **NOW \$14,995** SAVE \$6,952 (888) 682-3036 Churchville, NY STK #CHU64919



**USED 2006 Keystone SPRINGDALE 291** WAS \$21,233 **NOW \$14,995** SAVE \$6,238 (888) 860-8684 Strafford, MO STK #STR12769B



**USED 2006 Coachmen CAPTIVA 280** WAS \$20,995 **NOW \$14,995** SAVE \$6,000 (888) 902-8565 Tallahassee, FL STK #TAL39726



**USED 2005 K-Z DURANGO 280FL** WAS \$21,514 **NOW \$14,998** SAVE \$6,516 (888) 457-4801 Colfax, NC STK #CFX4099



**NEW 2010 Coleman COLEMAN CT250** WAS \$27,152 **NOW \$14,999** SAVE \$12,153 (866) 289-0113 Chattanooga, TN STK #CH5382



**USED 2007 Keystone COPPER CANYON 3121SLS** WAS \$25,900 **NOW \$14,999** SAVE \$10,901 (888) 489-5784 Knoxville, TN STK #KNOX19658



**NEW 2010 Dutchmen FREEDOM SPIRIT FSU240** WAS \$23,171 **NOW \$14,999** SAVE \$8,172 (866) 289-0113 Chattanooga, TN STK #CH6197



**USED 2008 Dutchmen FREEDOM SPIRIT FS260F-DSL** WAS \$22,900 **NOW \$14,999** SAVE \$7,901 (888) 489-5784 Knoxville, TN STK #KNOX19695



**USED 2010 National QUICKSILVER M-8.5X16 LQ** **NOW \$15,500** (888) 727-2952 North Little Rock, AR STK #LIT14952



**USED 2009 Dutchmen RAINIER 25C** WAS \$22,950 **NOW \$15,900** SAVE \$7,050 (888) 850-5575 Wood Village, OR STK #P0R37483



**USED 2008 Keystone OUTBACK 18RS** WAS \$23,448 **NOW \$15,985** SAVE \$7,463 (888) 484-3906 Spartanburg, SC STK #GR125709



**USED 2004 Keystone SPRINTER 297BH** **NOW \$15,995** (888) 331-1595 Santa Clarita, CA STK #AMRV22266 VIN #215980



**USED 2009 Palomino THOROUGHBRED T-26FBS** **NOW \$15,995** (888) 617-5406 Oakwood, GA STK #ORV15887



**USED 2004 Fleetwood TERRY QUANTUM 2952BS NOW \$15,995** (888) 815-7523 Woodstock, GA STK #WDS15796



**USED 2007 Cruiser RV LAND ROAMER 295RL WAS \$29,995 NOW \$15,995 SAVE \$14,000** (888) 682-3036 Churchville, NY STK #CHU69751



**NEW 2011 Keystone BULLET 188EXP MSRP \$23,348 NOW \$15,995 SAVE \$7,353** (888) 617-5406 Oakwood, GA STK #ORV15779



**USED 2006 Forest River CEDAR CREEK 31LBHS WAS \$29,500 NOW \$15,995 SAVE \$13,505** (866) 996-3140 Calera, AL STK #CLE19280



**USED 2009 Forest River SURVEYOR SV264 WAS \$25,995 NOW \$15,995 SAVE \$10,000** (888) 903-6787 Harrisburg, PA STK #HAR68628



**USED 2006 Coachmen CAPTIVA 265 WAS \$21,995 NOW \$15,995 SAVE \$6,000** (866) 415-9726 Wheat Ridge, CO STK #KC5CG1047A



**NEW 2011 Keystone HIDEOUT 19FLB MSRP \$21,089 NOW \$15,995 SAVE \$5,094** (888) 542-3819 Mesa, AZ STK #MES14824



**USED 2007 Gulf Stream MAKO 27FRBW WAS \$30,595 NOW \$15,999 SAVE \$14,596** (888) 489-5784 Knoxville, TN STK #KNOX19645



**USED 2005 Forest River WILDCAT 285 WAS \$22,697 NOW \$15,999 SAVE \$6,698** (888) 672-5049 Syracuse, NY STK #SYU68884



**USED 2008 Keystone COUGAR 29RLS NOW \$16,977** (888) 801-3226 Byron, GA STK #MAC15412



**USED 2007 Dutchmen FREEDOM SPIRIT 310B-DSL NOW \$16,995** (888) 668-6715 Katy, TX STK #KAT8961A



**USED 2010 Dutchmen FREEDOM SPIRIT FSU240 NOW \$16,995** (888) 905-0490 Anthony, TX STK #LC15669C



**USED 2003 Forest River CARDINAL 36RLE WAS \$31,995 NOW \$16,995 SAVE \$15,000** (888) 903-6787 Harrisburg, PA STK #HAR66181



**USED 2004 K-Z VISION ULTRA WAS \$28,690 NOW \$16,995 SAVE \$11,695** (866) 610-5049 Akron, OH STK #SRV18138



**USED 2005 Alfa SEE YA 35RL WAS \$27,275 NOW \$16,995 SAVE \$10,280** (888) 692-9016 Myrtle Beach, SC STK #MB126022



**NEW 2011 Jayco OCTANE SUPER LITE 161 WAS \$26,765 NOW \$16,995 SAVE \$9,770** (888) 819-7952 Longmont, CO STK #KC111208



**NEW 2011 Jayco OCTANE SUPER LITE 161** MSRP \$24,765 **NOW \$16,995** SAVE \$7,770 (888) 617-5406 Oakwood, GA STK #ORV15641



**NEW 2011 Crossroads SLINGSHOT 23CK** WAS \$28,871 **NOW \$16,999** SAVE \$11,872 (888) 471-3546 Chichester, NH STK #GRV507131



**NEW 2011 Coleman COLEMAN CTS274BH** WAS \$23,995 **NOW \$16,999** SAVE \$6,996 (866) 755-9604 Charleston, SC STK #CHN125242



**USED 2009 Dutchmen DUTCHMEN 28LGS** **NOW \$17,495** (888) 696-2165 Savannah, GA STK #SAV16309



**NEW 2011 Dutchmen KODIAK 250BHSL** WAS \$24,842 **NOW \$17,765** SAVE \$7,077 (888) 242-0293 Madison, WI STK #MAD16562



**USED 2007 Keystone MOUNTAINEER 32PHD** WAS \$30,995 **NOW \$17,858** SAVE \$13,137 (888) 254-9145 Meridian, ID STK #MER15610



**USED 2008 Pacific Coachworks TANGO 2760** WAS \$23,999 **NOW \$17,858** SAVE \$6,141 (888) 254-9145 Meridian, ID STK #MER16226



**NEW 2011 Crossroads SLINGSHOT 24RL** WAS \$29,483 **NOW \$17,977** SAVE \$11,506 (888) 471-3546 Chichester, NH STK #GRV507048



**USED 2009 Dutchmen ARISTOCRAT 26B-DSL** WAS \$24,988 **NOW \$17,988** SAVE \$7,000 (888) 475-5918 Robertsdale, AL STK #RD39053



**USED 2008 Keystone COUGAR 29RSL** WAS \$23,690 **NOW \$17,995** SAVE \$5,695 (866) 610-5049 Akron, OH STK #SRV18236



**USED 2009 Keystone SPRINTER 250RBS** WAS \$28,900 **NOW \$17,999** SAVE \$10,901 (888) 489-5784 Knoxville, TN STK #KNOX19536



**USED 2007 Keystone COUGAR 29BHS** WAS \$27,989 **NOW \$17,999** SAVE \$9,990 (877) 554-3516 Lakewood, NJ STK #LAK8618



**USED 2005 Keystone COUGAR 309EFS** WAS \$23,989 **NOW \$17,999** SAVE \$5,990 (877) 554-3516 Lakewood, NJ STK #LAK8619



**NEW 2011 Keystone HIDEOUT 25RKS** WAS \$25,659 **NOW \$18,444** SAVE \$7,215 (888) 454-1707 Kissimmee, FL STK #KS8166



**NEW 2010 Coleman COLEMAN CT250** MSRP \$26,548 **NOW \$18,690** SAVE \$7,858 (888) 348-5909 Avondale, AZ STK #AVO14816



**USED 2008 Crossroads ZINGER 30QB** **NOW \$18,960** (888) 696-2165 Savannah, GA STK #SAV16298



**NEW 2011 Starcraft TRAVEL STAR 245RBS** WAS \$29,309 **NOW \$18,988** SAVE \$10,321 (888) 457-4801 Colfax, NC STK #CFX4097



**NEW 2011 Starcraft TRAVEL STAR 285RLSA** WAS \$28,000 **NOW \$18,995** SAVE \$9,005 (866) 502-8238 Bath, NY STK #BAT66797



**NEW 2011 Dutchmen DUTCHMEN 295BHGS** WAS \$26,995 **NOW \$18,995** SAVE \$8,000 (888) 484-3906 Spartanburg, SC STK #GR123696



**USED 2009 Keystone COUGAR 245RKS** WAS \$29,900 **NOW \$18,999** SAVE \$10,901 (888) 489-5784 Knoxville, TN STK #KNOX19540



**USED 2007 Keystone OUTBACK SYDNEY 30RLS** **NOW \$18,996** (888) 815-7523 Woodstock, GA STK #WDS16084



**NEW 2011 Coleman COLEMAN CTS260BH** WAS \$31,262 **NOW \$18,997** SAVE \$12,265 (877) 450-7415 Island Lake, IL STK #CRV5742



**NEW 2011 Crossroads SLINGSHOT 23CK** WAS \$27,695 **NOW \$18,999** SAVE \$8,696 (866) 648-5288 St. Augustine, FL STK #JAC37710



**USED 2008 Keystone COUGAR 29** **NOW \$19,487** (888) 641-0925 Kaysville, UT STK #KY37660



**NEW 2010 Coleman COLEMAN CT225** WAS \$30,806 **NOW \$19,500** SAVE \$11,306 (888) 484-3906 Spartanburg, SC STK #GR122980



**NEW 2011 Starcraft AUTUMN RIDGE 256BHS** WAS \$26,232 **NOW \$19,504** SAVE \$6,728 (888) 625-5187 Fort Myers, FL STK #FTM12079



**NEW 2011 Crossroads SLINGSHOT 27RB** WAS \$30,663 **NOW \$19,896** SAVE \$10,767 (888) 242-0293 Madison, WI STK #MAD15063



**NEW 2011 Coleman COLEMAN CTS264RL** WAS \$28,654 **NOW \$19,950** SAVE \$8,704 (888) 859-6653 Hillsboro, OR STK #HIL37478



**NEW 2011 Jayco JAY FEATHER SELECT 28U** WAS \$31,500 **NOW \$19,980** SAVE \$11,520 (888) 896-2801 Albuquerque, NM STK #ARV15582



**USED 2010 Keystone OUTBACK 30BHDS** WAS \$46,684 **NOW \$19,995** SAVE \$26,689 (866) 775-0682 Roanoke, VA STK #ROA18612



**NEW 2011 Starcraft AUTUMN RIDGE 329BHU** WAS \$34,639 **NOW \$19,995** SAVE \$14,644 (866) 754-7302 Greenwood, IN STK #GRW325337



**NEW 2011 Keystone PASSPORT 2850RL** WAS \$29,278 **NOW \$19,995** SAVE \$9,283 (888) 682-3036 Churchville, NY STK #CHU65553



**NEW 2011 Keystone HIDEOUT 27BHS** MSRP \$27,778 **NOW \$19,995** SAVE \$7,783 (888) 542-3819 Mesa, AZ STK #MES14826



**USED 2007 Frontier RV ASPEN 30RLBS**  
 WAS \$29,997 **NOW \$19,997** SAVE  
 \$10,000 (888) 463-3995 Colorado Springs,  
 CO STK #KC210631B



**NEW 2011 Keystone**  
**HORNET 27FLBS** WAS  
 \$32,985 **NOW \$19,999**  
 SAVE \$12,986 (877)  
 554-3516 Lakewood,  
 NJ STK #LAK8461



**USED 2007 Keystone SYDNEY OUTBACK**  
**31FRKS** WAS \$29,998 **NOW \$19,999**  
 SAVE \$9,999 (877) 554-3516 Lakewood,  
 NJ STK #LAK8509



**NEW 2012 Forest River MAVERICK 2902** WAS  
 \$28,977 **NOW \$19,999** SAVE \$8,978 (866) 415-  
 9726 Wheat Ridge, CO STK #KC511708



**NEW 2011 Keystone HORNET 28RLS**  
 WAS \$28,883 **NOW \$20,995** SAVE \$7,888  
 (888) 454-1707 Kissimmee, FL STK  
 #KS7877



**USED 2009 Keystone SYDNEY 29RLS**  
 WAS \$34,900 **NOW \$20,999** SAVE  
 \$13,901 (888) 489-5784 Knoxville, TN STK  
 #KNOX19537



**NEW 2011 Coleman**  
**COLEMAN CTS260BH**  
 WAS \$30,175 **NOW**  
**\$21,444** SAVE \$8,731  
 (888) 454-1707 Kissim-  
 mee, FL STK #KS8063



**NEW 2011 Coleman**  
**COLEMAN CTU225KS**  
 WAS \$30,806 **NOW**  
**\$21,457** SAVE \$9,349  
 (888) 474-1330 Bartow,  
 FL STK #DCW7799



**USED 2008 Keystone SYDNEY 31FRL**  
 WAS \$36,895 **NOW \$21,589** SAVE  
 \$15,306 (866) 755-9604 Charleston, SC  
 STK #CHN125687



**USED 1998 Nu Wa SNOWBIRD RL1GBW**  
**36.2** WAS \$31,999 **NOW \$21,858** SAVE  
 \$10,141 (888) 254-9145 Meridian, ID STK  
 #MER15253



**USED 2010 Keystone BULLET 246RBS**  
**NOW \$21,960** (888) 696-2165 Savan-  
 nah, GA STK #SAV16297



**NEW 2011 Keystone**  
**HORNET 28BHS** WAS  
 \$31,590 **NOW \$21,995**  
 SAVE \$9,595 (888) 860-  
 8684 Strafford, MO STK  
 #STR14172



**USED 2010 Keystone SPRINTER 276RLS**  
**NOW \$21,998** (888) 815-7523 Wood-  
 stock, GA STK #WDS16040



**NEW 2010 Dutchmen AEROLITE**  
**27QSTH-SL** WAS \$34,035 **NOW \$21,999**  
 SAVE \$12,036 (866) 289-0113 Chattanoo-  
 ga, TN STK #CH6205



**NEW 2011 Coleman COLEMAN**  
**CTU289RL** WAS \$30,445 **NOW \$22,503**  
 SAVE \$7,942 (888) 625-5187 Fort Myers,  
 FL STK #FTM13416



**USED 2007 Jayco EAGLE 32** **NOW**  
**\$22,979** (888) 479-3568 Vacaville, CA  
 STK #VAC17589 VIN #CA0096



**USED 2007 Gulf Stream SEDONA**  
**29RKFV** WAS \$46,999 **NOW \$22,995**  
 SAVE \$24,004 (866) 648-5288 St. Augus-  
 tine, FL STK #JAC38696



**NEW 2011 Coleman COLEMAN CT275REX** WAS \$49,358 **NOW \$23,900** SAVE \$25,458 (866) 755-9604 Charleston, SC STK #CHN125203



**NEW 2011 Keystone COUGAR 29FKS** WAS \$37,097 **NOW \$23,995** SAVE \$13,102 (888) 860-8684 Strafford, MO STK #STR11522



**NEW 2011 Keystone SPRINTER 262FWRET** MSRP \$35,242 **NOW \$24,590** SAVE \$10,652 (888) 617-5406 Oakwood, GA STK #ORV15162



**NEW 2011 Keystone COUGAR 26BRS** WAS \$36,683 **NOW \$23,995** SAVE \$12,688 (888) 860-8684 Strafford, MO STK #STR13235



**NEW 2011 Starcraft LEXION S-LITE 256RKU** WAS \$42,125 **NOW \$23,997** SAVE \$18,128 (877) 450-7415 Island Lake, IL STK #CRV5676



**NEW 2011 Starcraft LEXION S-LITE 314RE** WAS \$35,355 **NOW \$24,617** SAVE \$10,738 (888) 474-1330 Bartow, FL STK #DCW7903



**USED 2011 Keystone OUTBACK 230RS** **NOW \$24,960** (888) 696-2165 Savannah, GA STK #SAV16218



**USED 2007 Gulf Stream SEDONA 34FSBW** **NOW \$24,974** (888) 641-0925 Kaysville, UT STK #KY36139



**NEW 2011 Keystone FUZION 230** MSRP \$43,647 **NOW \$24,975** SAVE \$18,672 (888) 614-5201 Draper, UT STK #ABRV37054



**NEW 2011 Keystone PREMIER 28RL** WAS \$39,627 **NOW \$24,980** SAVE \$14,647 (888) 896-2801 Albuquerque, NM STK #ARV15419



**NEW 2011 Dutchmen DENALI 261BH** WAS \$35,533 **NOW \$24,995** SAVE \$10,538 (888) 475-5918 Robertsdale, AL STK #RD38588



**NEW 2011 Keystone OUTBACK 230RS** LIST PRICE \$35,499 **NOW \$24,995** SAVE \$10,504 (888) 331-1595 Santa Clarita, CA STK #AMRV22157 VIN #451822



**USED 2004 Keystone MONTANA BIG SKY 3670** WAS \$32,995 **NOW \$24,995** SAVE \$8,000 (888) 450-7060 Dothan, AL STK #DOT39023



**USED 2003 K-Z NEW VISION 3450** **NOW \$25,900** (888) 844-1758 New Braunfels, TX STK #SWC9599



**USED 2008 Jayco OCTANE 26Y** **NOW \$25,995** (888) 614-5201 Draper, UT STK #ABRV37425



**NEW 2011 Jayco EAGLE 320RLDS** WAS \$39,301 **NOW \$25,995** SAVE \$13,306 (888) 819-7952 Longmont, CO STK #KC111199



**NEW 2011 Dutchmen RUBICON 2100**  
LIST PRICE \$37,782 **NOW \$25,995** SAVE  
\$11,787 (888) 331-1595 Santa Clarita, CA  
STK #AMRV22598 VIN #207377



**NEW 2011 Dutchmen RUBICON 2100**  
LIST PRICE \$37,782 **NOW \$25,995** SAVE  
\$11,787 (888) 331-1595 Santa Clarita, CA  
STK #AMRV22597 VIN #207376



**USED 2006 Keystone CHALLENGER 34TBH** WAS \$34,685 **NOW \$25,995** SAVE  
\$8,690 (888) 315-7967 Tucson, AZ STK #TUC13516



**NEW 2011 Keystone LAREDO 297RL** LIST PRICE  
\$36,170 **NOW \$26,121** SAVE \$10,049 (888) 479-  
3568 Vacaville, CA STK #VAC12635 VIN #601337



**USED 2007 Gulf Stream SEDONA 34FBRW** WAS \$43,524 **NOW \$26,877**  
SAVE \$16,647 (866) 996-3140 Calera, AL  
STK #CLE19279



**NEW 2011 Coleman COLEMAN CT275REX** WAS \$42,375 **NOW \$26,950**  
SAVE \$15,425 (888) 475-5918 Robertsdale,  
AL STK #RD38336



**NEW 2011 Keystone FUZION 230** WAS  
\$41,680 **NOW \$26,988**  
SAVE \$14,692 (866) 673-  
0250 Statesville, NC STK  
#STA125714



**NEW 2011 Starcraft LEXION S-LITE 256RKU**  
WAS \$37,333 **NOW \$26,995** SAVE \$10,338  
(888) 625-5187 Fort My-  
ers, FL STK #FTM12093



**USED 2006 Sunnybrook MOBILE SCOUT 31BWFS** WAS \$35,444 **NOW \$26,995**  
SAVE \$8,449 (888) 348-5909 Avondale, AZ  
STK #AV014593



**NEW 2011 Keystone OUTBACK 301BQ**  
WAS \$38,014 **NOW \$26,999** SAVE  
\$11,015 (888) 674-0275 Gulf Breeze, FL  
STK #GB39904



**NEW 2011 Starcraft LEXION S-LITE 3090K** LIST PRICE \$38,367 **NOW \$27,774**  
SAVE \$10,593 (888) 480-3175 Sacramen-  
to, CA STK #SAC12162 VIN #DH5064



**NEW 2011 Coleman COLEMAN CT275REX**  
LIST PRICE \$39,782 **NOW \$27,777** SAVE  
\$12,005 (888) 479-  
3568 Vacaville, CA STK  
#VAC17588 VIN #627105



**NEW 2012 Crossroads CRUISER 29RLX**  
WAS \$39,164 **NOW \$27,838** SAVE  
\$11,326 (888) 386-5187 Houghton Lake,  
MI STK #HL5887



**USED 2011 Keystone COPPER CANYON 292BH** WAS \$41,339 **NOW \$27,877** SAVE  
\$13,462 (866) 996-3140 Calera, AL STK  
#CLE19284



**USED 2008 Forest River SANDPIPER 305RLW** **NOW \$27,900** (888) 668-6715  
Katy, TX STK #KAT9876



**NEW 2011 Keystone FUZION 230** WAS  
\$45,424 **NOW \$27,995** SAVE \$17,429  
(866) 820-0335 Council Bluffs, IA STK  
#CBI13613



**NEW 2011 Keystone OUTBACK 285FL**  
WAS \$37,128 **NOW \$27,999** SAVE  
\$9,129 (877) 554-3516 Lakewood, NJ STK  
#LAK8189



**NEW 2011 Starcraft LEXION S-LITE 256RKU** WAS \$44,084 **NOW \$28,458** SAVE \$15,626 (866) 775-0682 Roanoke, VA STK #ROA12129



**NEW 2011 Jayco OCTANE ZX T24Z** WAS \$41,402 **NOW \$28,980** SAVE \$12,422 (888) 896-2801 Albuquerque, NM STK #ARV15609



**USED 2011 Coachmen CATALINA 38 BHDS** WAS \$49,589 **NOW \$29,589** SAVE \$20,000 (866) 755-9604 Charleston, SC STK #CHN125655



**NEW 2011 Keystone OUTBACK 280RS** WAS \$38,995 **NOW \$28,995** SAVE \$10,000 (888) 902-8565 Tallahassee, FL STK #TAL39149



**NEW 2011 Jayco EAGLE SUPER LITE 31.5RLTS** WAS \$44,293 **NOW \$29,250** SAVE \$15,043 (866) 415-9726 Wheat Ridge, CO STK #KC510894



**USED 2005 Fleetwood TRIUMPH 395RL** WAS \$47,695 **NOW \$29,858** SAVE \$17,837 (888) 692-9016 Myrtle Beach, SC STK #MB125365



**USED 2005 Alfa SEE YA SYF30RL** **NOW \$29,876** (888) 480-3175 Sacramento, CA STK #SAC15534 VIN #013427



**NEW 2011 Coleman COLEMAN CT-F267BH** WAS \$39,666 **NOW \$29,950** SAVE \$9,716 (888) 859-6653 Hillsboro, OR STK #HIL37504



**NEW 2011 Starcraft LEXION S-LITE 295RLS** LIST PRICE \$43,392 **NOW \$29,955** SAVE \$13,437 (888) 480-3175 Sacramento, CA STK #SAC12169 VIN #PE5065



**NEW 2011 Coleman COLEMAN CT-F267BH** **NOW \$29,993** (888) 727-2952 North Little Rock, AR STK #LIT14254



**USED 2006 Keystone MONTANA 3600RE** **NOW \$29,995** (888) 801-3226 Byron, GA STK #MAC16137



**NEW 2011 Keystone SYDNEY 329FBH** MSRP \$44,401 **NOW \$29,995** SAVE \$14,406 (888) 617-5406 Oakwood, GA STK #ORV15032



**NEW 2011 Keystone FUZION 230** MSRP \$43,065 **NOW \$29,995** SAVE \$13,070 (888) 542-3819 Mesa, AZ STK #MES16789



**NEW 2011 Coleman COLEMAN CT275REX** WAS \$41,873 **NOW \$29,995** SAVE \$11,878 (877) 289-0812 Las Vegas, NV STK #LVN37006



**NEW 2011 Coleman COLEMAN CTF259RE** WAS \$40,266 **NOW \$29,995** SAVE \$10,271 (877) 289-0812 Las Vegas, NV STK #LVN36711



**NEW 2011 Coleman COLEMAN CT-F325RL** WAS \$43,759 **NOW \$29,999** SAVE \$13,760 (877) 554-3516 Lakewood, NJ STK #LAK608563





**NEW 2011 Keystone LAREDO 266RL**  
MSRP \$42,663 **NOW \$31,751** SAVE  
\$10,912 (888) 905-0490 Anthony, TX STK  
#LC15353



**NEW 2010 Dutchmen COLORADO 32RL** MSRP \$44,036  
**NOW \$31,995** SAVE  
\$12,041 (888) 348-  
5909 Avondale, AZ STK  
#AV014439



**NEW 2011 Keystone FUZION 230** LIST  
PRICE \$46,267 **NOW \$32,753** SAVE  
\$13,514 (877) 834-0429 Bakersfield, CA  
STK #SLV21363 VIN #810503



**USED 2007 Alfa SEE YA 35RLIK 314** WAS \$62,888  
**NOW \$32,777** SAVE \$30,111 (877) 289-0812 Las  
Vegas, NV STK #LVN36462A



**NEW 2011 Coleman COLEMAN CT320BS**  
WAS \$46,807 **NOW \$32,950** SAVE  
\$13,857 (888) 859-6653 Hillsboro, OR STK  
#HIL38189



**USED 2007 Weekend Warrior WEEKEND WARRIOR 4005FTL** **NOW \$32,987** (888) 641-0925 Kaysville, UT STK #KY37160



**USED 2007 Alpenlite VOYAGER 31CK**  
\$49,900 **NOW \$32,999**  
SAVE \$16,901 (866) 289-  
0113 Chattanooga, TN  
STK #CH6868



**USED 2008 Heartland BIGHORN 3400RL**  
**NOW \$33,251** (888)  
479-3568 Vacaville, CA  
STK #VAC12678 VIN  
#005869



**USED 2006 Carriage CAMEO 35KS3**  
**NOW \$33,779** (888) 801-3226 Byron, GA  
STK #MAC16043



**NEW 2011 Starcraft LEXION S-LITE 315BSSA** LIST PRICE \$49,552 **NOW \$33,952**  
SAVE \$15,600 (888) 480-3175 Sacramento, CA STK #SAC12171 VIN #PT5072



**USED 2007 Heartland LANDMARK SHENANDOAH** WAS \$49,888 **NOW \$34,988** SAVE \$14,900 (888) 348-5909 Avondale, AZ STK #AV013837



**USED 2009 Keystone COUGAR 276RLS** WAS \$54,289 **NOW \$34,995** SAVE \$19,294 (866) 820-0335 Council Bluffs, IA STK #CBI18632



**NEW 2011 Heartland ELKRIDGE 29BHCK**  
WAS \$45,996 **NOW \$34,995** SAVE  
\$11,001 (888) 896-2801 Albuquerque, NM  
STK #ARV15889



**USED 2008 Dutchmen GRAND JUNCTION 31TKS** WAS \$58,995 **NOW \$35,999** SAVE \$22,996 (888) 672-5049 Syracuse, NY STK #SYU68515



**NEW 2011 Jayco EAGLE 321RLTS** MSRP \$53,665 **NOW \$36,550** SAVE \$17,115 (888) 617-5406 Oakwood, GA STK #ORV15226



**USED 2008 Heartland BIG HORN 3055RL** **NOW \$36,900** (888) 844-1758 New Braunfels, TX STK #SW9751A



**NEW 2011 Keystone SYDNEY 325FRE**  
WAS \$49,096 **NOW \$36,997** SAVE  
\$12,099 (888) 463-3995 Colorado Springs, CO STK #KC211295



**USED 2006 Nu Wa HITCHHIKER 35LKR5B PREMIER** WAS \$48,997 **NOW \$36,997** SAVE \$12,000 (888) 463-3995 Colorado Springs, CO STK #KC2CS960B



**USED 2006 Alfa SEE YA 35RLIK NOW \$38,995** (888) 641-0925 Kaysville, UT STK #KY37748



**USED 2008 Heartland BIG HORN 3600RL** WAS \$52,798 **NOW \$39,858** SAVE \$12,940 (866) 673-0250 Statesville, NC STK #STA126284



**USED 2010 Dutchmen GRAND JUNCTION 355 RL** WAS \$72,895 **NOW \$39,783** SAVE \$33,112 (888) 450-7060 Dothan, AL STK #DOT39487



**USED 2006 Heartland LANDMARK GOLDEN GATE** WAS \$59,999 **NOW \$39,858** SAVE \$20,141 (866) 648-5288 St. Augustine, FL STK #JAC38916



**NEW 2011 Keystone MONTANA HIGH COUNTRY 333DB** MSRP \$59,435 **NOW \$39,977** SAVE \$19,458 (888) 801-3226 Byron, GA STK #MAC15324



**USED 2008 Carriage CAMEO 35SB3 NOW \$39,889** (888) 801-3226 Byron, GA STK #MAC15470



**NEW 2011 Keystone MOUNTAINEER 335RET** WAS \$58,262 **NOW \$39,897** SAVE \$18,365 (888) 903-6787 Harrisburg, PA STK #HAR67896



**USED 2007 West-ern ALPENLITE 34RL NOW \$39,995** (888) 668-6715 Katy, TX STK #KAT9870



**USED 2010 Keystone EVEREST 340I NOW \$39,995** (888) 905-0490 Anthony, TX STK #LC15682A



**NEW 2011 Forest River SANDSTORM 3215SRS** MSRP \$55,114 **NOW \$39,995** SAVE \$15,119 (888) 905-0490 Anthony, TX STK #LC15520



**NEW 2011 Keystone MONTANA HIGH COUNTRY 323RL** MSRP \$61,011 **NOW \$42,987** SAVE \$18,024 (888) 641-0925 Kaysville, UT STK #KY35843



**NEW 2010 Dutchmen GRAND JUNCTION 350RE** WAS \$71,301 **NOW \$43,995** SAVE \$27,306 (866) 754-7302 Greenwood, IN STK #GRW352591



**NEW 2011 Starcraft LEXION 355RESA** WAS \$68,702 **NOW \$44,799** SAVE \$23,903 (866) 775-0682 Roanoke, VA STK #ROA12132



**NEW 2011 Keystone MONTANA HIGH COUNTRY 333DB** WAS \$66,572 **NOW \$44,995** SAVE \$21,577 (877) 289-0812 Las Vegas, NV STK #LVN38423



**NEW 2011 Forest River CEDAR CREEK 30RL** WAS \$65,374 **NOW \$45,344** SAVE \$20,030 (888) 903-6787 Harrisburg, PA STK #HAR68359



**NEW 2011 Keystone MONTANA HIGH COUNTRY 343RL** WAS \$64,388 **NOW \$45,951** SAVE \$18,437 (888) 242-0293 Madison, WI STK #MAD18832



**USED 2010 Keystone MONTANA 3150** WAS \$69,989 **NOW \$45,988** SAVE \$24,001 (866) 755-9604 Charleston, SC STK #CHN125677



**USED 2006 Carriage CARRI LITE 36XTRM5** WAS \$62,995 **NOW \$45,995** SAVE \$17,000 (866) 775-0682 Roanoke, VA STK #ROA13811



**NEW 2011 Keystone MONTANA 3455SA** **NOW \$46,866** (888) 727-2952 North Little Rock, AR STK #LIT10490



**NEW 2011 Keystone MONTANA 3665RE** MSRP \$83,712 **NOW \$47,986** SAVE \$35,726 (888) 614-5201 Draper, UT STK #ABRV36630



**NEW 2011 Keystone MONTANA 3455SA** **NOW \$49,900** (888) 727-2952 North Little Rock, AR STK #LIT12714



**NEW 2011 Keystone RAPTOR 400RBG** WAS \$80,169 **NOW \$49,995** SAVE \$30,174 (866) 502-8238 Bath, NY STK #BAT65845



**NEW 2011 Jayco PINNACLE 35LKTS** WAS \$77,706 **NOW \$49,995** SAVE \$27,711 (888) 819-7952 Longmont, CO STK #KC111168



**NEW 2010 Dutchmen GRAND JUNCTION 350RE** WAS \$76,828 **NOW \$49,995** SAVE \$26,833 (877) 289-0812 Las Vegas, NV STK #LVN39701



**NEW 2011 Keystone FUZION 400** WAS \$68,491 **NOW \$49,995** SAVE \$18,496 (888) 474-1330 Bartow, FL STK #DCW8105



**NEW 2011 Dutchmen GRAND JUNCTION 340RL** MSRP \$72,597 **NOW \$51,311** SAVE \$21,286 (888) 315-7967 Tucson, AZ STK #TUC13319



**NEW 2011 Jayco PINNACLE 34RLTS** WAS \$72,278 **NOW \$51,995** SAVE \$20,283 (866) 415-9726 Wheat Ridge, CO STK #KC511165



**NEW 2011 Coleman COLEMAN CT-F340RL** WAS \$76,135 **NOW \$55,950** SAVE \$20,185 (888) 850-5575 Wood Village, OR STK #POR37616



**NEW 2011 Keystone MONTANA 3455SA** WAS \$78,842 **NOW \$56,998** SAVE \$21,844 (888) 457-4801 Colfax, NC STK #CFX3935



**NEW 2011 Keystone FUZION 360** WAS \$90,513 **NOW \$59,974** SAVE \$30,539 (888) 450-7060 Dothan, AL STK #DOT40786



**NEW 2011 Keystone MONTANA 3665RE** WAS \$79,058 **NOW \$59,995** SAVE \$19,063 (877) 289-0812 Las Vegas, NV STK #LVN36983



**NEW 2011 Heartland LANDMARK GRAND CANYON** WAS \$99,098 **NOW \$72,995** SAVE \$26,103 (866) 996-3140 Calera, AL STK #CLE19288



# 10-MINUTE TECH

A compilation of tried-and-true tips **From RVers**



## KITTY OR KIDDIE? †

We travel with three cats in our fifth-wheel, and we were worried that they would ruin the screen in the door with their scratching. We have seen people install plexiglas on the screen for just such a problem, but we didn't want to lose the airflow the screen provides.

I purchased a kiddie gate from Wamart, separated the two halves and mounted one of the sides to the lower portion of the screen door. Now our cats don't scratch the screen, and we still have the desired airflow.

**Max Long, Star, Idaho**

## HELPING HAND

I discovered while packing up from our most recent trip that barbecue mitts work perfectly to cover and protect liquor bottles for travel. They fit right over the bottles and secure them while in motion. I tuck ours in the back of the cupboard until we're all set up and ready to begin our vacation.

**Phyllis Hudson, Camillus, New York**

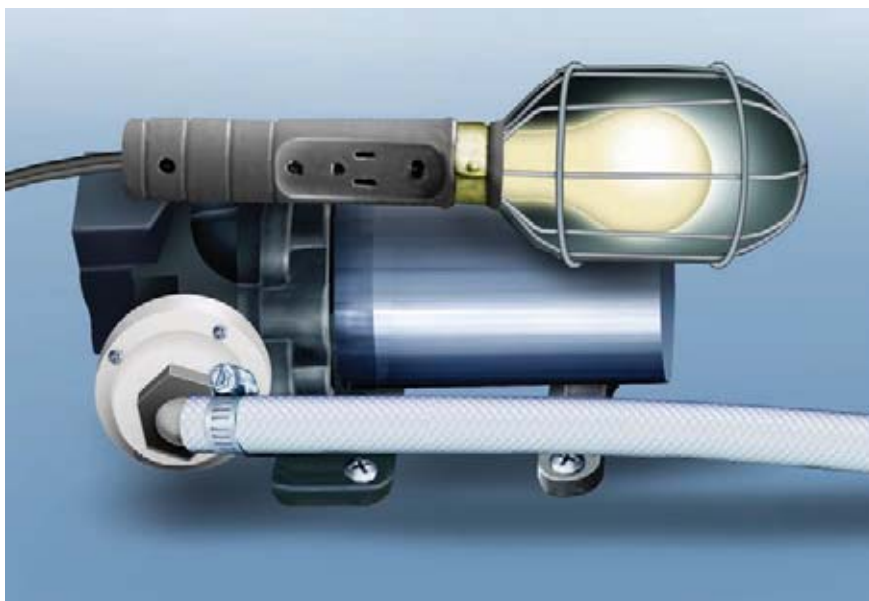

## KEEP ON PUMPING †

We use our RV throughout the year and often find ourselves in sub-freezing temperatures. One of the most vulnerable places on an RV is the water pump. To prevent the pump from freezing or from possible damage, we installed a work light in the pump compartment. We use a 60-watt bulb, and the system has never frozen.

**Ray McCalment, Depew, Oklahoma**

## SINGE-FREE SCENTS †

I enjoy the aroma of a scented candle, but having an open flame is a recipe for disaster should we forget to extinguish it. I found that a great way to lightly scent the air in our trailer is by placing a scented candle on a coffee-mug warmer. You can find them for less than \$10 online. As the candle wax melts, it releases the pleasant aroma without the worries of an open flame.

**Joe & Debra Sherrill, Monroe, North Carolina**



Illustrations by Bill Tipton

To send your submission, write to 3300 Fernbrook Lane N, Suite 200, Minneapolis, MN 55447. Please include an illustration if applicable.

Continued from page 60 ...

the goal for large pickups will be 33 mpg.

With higher fuel-economy standards, the government claims consumption will be reduced by as much as 3.8 million barrels of petroleum per day and that the average family will spend up to \$8,000 less on fuel per vehicle. The United States could cut CO<sub>2</sub> emissions 6 million metric tons of CO<sub>2</sub> by 2025.

However, the new regulations come at a cost too. Automakers must pass on the cost of technological improvements to buyers. While estimates vary, the new standards could add between \$1,500 and \$6,500 per new vehicle. Enforcing the rules already implemented for the period 2012-2016 is expected to cost \$51.5 billion, or \$950 per vehicle on average by 2016. Consumers can expect the new regulations to result in additional fuel mileage improvements, but it's also likely that maximum tow ratings of vehicles popular for towing will also be reduced as vehicle weights and horsepower are reduced in the quest for improved fuel economy.

#### AIRSTREAM RECALL

Airstream is recalling certain model year 2011-2012 16-foot International trailers manufactured from May 10, 2010, through September 27, 2011. These vehicles were manufactured with the incorrect tire-information label. During replacement of the tires, a consumer could install the incorrect tire, potentially leading to property damage. Airstream will mail the corrected label to owners or the customer will have the option for dealers to install the label free of charge. Owners may contact Airstream at (937) 596-6111.

#### JAYCO RECALL

Jayco is recalling certain model year 2007-2008 Jay Feather LGT travel trailers manufactured from October 9, 2006, through April 17, 2008. These travel trailers may have insufficient clearance between the tires and the wheel well. This could allow the tires to contact the wheel well increasing the risk of a crash. Jayco will notify owners, and Jayco dealers will add a spacer to increase the distance between the axle and the wheel well. This service will be performed free of charge. Owners may contact Jayco at (800) 283-8267. 



## Get From Point A to Point B Without Refueling!

### A Transfer Flow Fuel Tank Can Get You There!

**IN-BED AUXILIARY FUEL TANKS**      **LARGER REPLACEMENT FUEL TANKS**      **TOOLBOX & FUEL TANK COMBOS**

Whether it's an in-bed auxiliary fuel tank, a larger replacement fuel tank, or a toolbox and fuel tank combo, a Transfer Flow fuel tank will get you where you want to go! And with a Transfer Flow fuel tank installed on your pickup, you'll bypass the more expensive fuel stations, and fill up where fuel is cheaper! For a FREE catalog of our American-made fuel tanks, call 1-800-442-0056, or visit our website at [www.transferflow.com](http://www.transferflow.com).

**TRANSFER FLOW, INC.**  
Fuel Tank Systems  
The Leader in Aftermarket Fuel Tank Systems.™

1-800-442-0056 • (530) 893-5209  
[www.transferflow.com](http://www.transferflow.com)

facebook    twitter

NATIONWIDE INSTALLERS! CALL US FOR A LISTING NEAR YOU.

Transfer Flow, Circle 135 on Reader Service Card



## Hellwig PRODUCTS.COM

# DOES YOUR TRUCK SAG?

HELLWIG'S GOT THE SOLUTION:

LOAD CONTROL PRODUCTS, HELPER SPRINGS & AIR

AFFORDABLE HELPER SPRINGS      HEAVY DUTY AIR

## GOT SWAY?

SOLUTION: HELLWIG'S BIG WIG

THE BIG WIG  
Load Control Sway Control

VISIT OUR WEBSITE TO FIND YOUR APPLICATION  
[HELLWIGPRODUCTS.COM](http://HELLWIGPRODUCTS.COM) • 1-800-HELLWIG

Hellwig Products, Circle 136 on Reader Service Card



# Join Us!

At the Good Sam Rally  
in Phoenix, AZ March 22-25, 2012



High-octane entertainment comes to the **Good Sam Rally in Phoenix, presented by DISH Network**, with a fast-and-furious lineup — **Martina McBride**, country music's four-time winner of Female Vocalist of the Year, and **Bill Cosby**, everybody's favorite comedian! Plus, return to the golden age of the rockin' 50s with **Bowzer's Rock N' Roll Party** and sing along with **Ticket to Ride**, our favorite Beatles tribute band!

- Hundreds of informative seminars
- A huge trade show with the latest and greatest RVs
- More than 300 exhibit booths
- Earn Good Sam "Smiles" (tickets) and win tons of prizes!  
The more Smiles you earn, the greater your chances to win
- Optional tours of must-see Arizona destinations
- Pack your old military gear (whatever fits!) and dress out for the Rally's Veterans Parade or carry a flag in the Veteran Salute
- The chance to make hundreds of new RV friends

Good Sam sponsors **two more high-powered Rallies in 2012**—summer fun at the **Kentucky Exposition Center in Louisville, June 21–24**, and fall adventure at **Florida's Daytona International Speedway, November 2–4**. Both **presented by DISH Network**.

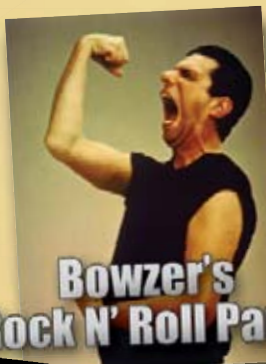

**Bowzer's  
Rock N' Roll Party**



**Ticket to Ride**



**Martina McBride**

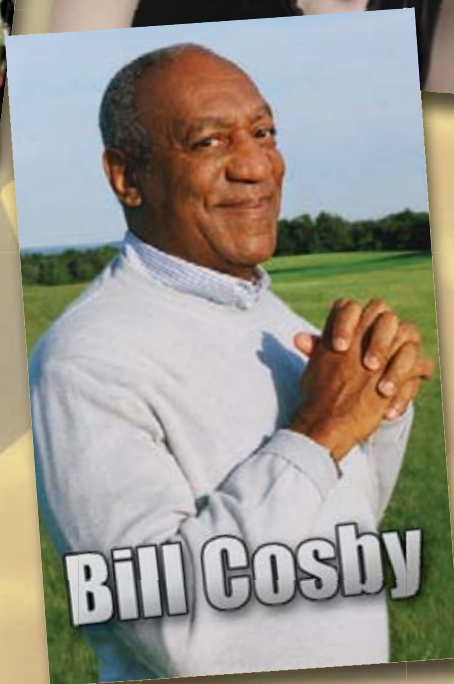

**Bill Cosby**

5402-CS



Good Sam Rally, Circle 133 on Reader Service Card

For more information or to register visit [TheRally.com](http://TheRally.com) or call the Rally hotline **800 70-1399**

# CLASSIFIEDS

## ACCESSORIES



**DOOR LIFT SYSTEMS for baggage compartments**  
Easy Installation — 30 minutes or less  
Slide-Out Kits, Replacement Springs  
[www.hatchlift.com](http://www.hatchlift.com) or call 303-233-6083

**LEAKY ROOF? Liquid Roof® goes on like paint** —  
cures to a sealed EPDM rubber membrane. UV &  
Ozone resistant — good to 300° F. 5-yr warranty.  
800-467-7135 [www.AdvancedRubberCoatings.com](http://www.AdvancedRubberCoatings.com)

**HENSLEY ARROW - RECONDITIONED LIKE NEW**  
Guaranteed to Eliminate Trailer Sway.  
Warranty and 60 Day Guarantee.  
[www.HensleyMfg.com](http://www.HensleyMfg.com) 1-800-410-6580 x117.

## AIR MATTRESSES

**DESIGNED AND SIZED FOR RVs**--Dual  
adjustable, air sleep systems. Custom sizes,  
money-back guarantee. Shipped factory direct.  
[www.bearbeds.com](http://www.bearbeds.com) Email: [info@bearbeds.com](mailto:info@bearbeds.com)

## CAMPGROUND MEMBERSHIPS FOR SALE

**CAMPGROUND MEMBERSHIP OUTLET-SINCE 1991**  
To buy 800-272-0401.  
To sell 800-952-0401.  
Any Membership-Nationwide. Best prices ever.

**MEMBERSHIP IN WESTERN HORIZONS at**  
St. David, Arizona. Plus 18 other resorts in  
USA. Coast to Coast affiliated. Carl Denman,  
520-883-6271.

## HELP WANTED

**SMOKY MTNS, NC--Couples to help maintain**  
small cpgd in Smokies. Full hookup in ex-  
change for part-time work. Open April thru Oct.  
Adventure Trail Cpgd., Box 1673, Cherokee, NC  
28719, (828) 497-3651. [www.atcampground.com](http://www.atcampground.com)

**THE BEST OF BOTH WORLDS—Travel and**  
stay in RV parks FREE. Set your own income  
selling advertising for RV parks. Up to 65%  
commission. Call 1-800-832-3292. Full training.

**GREAT JOBS IN GREAT PLACES! Experience**  
America one job at a time living the Workamper  
lifestyle. Jobs in campgrounds, parks, resorts,  
etc. For FREE BROCHURE & subscription info.  
800-446-5627 [www.workamper.com](http://www.workamper.com)

## HOMES FOR SALE



**NEW HOMES WITH CUSTOM GARAGES**  
In Laughlin, NV. 50' RV - 40' Boat Garages.  
3 Bedroom, 2 Bath, Single Story. Energy Star.  
**800-828-2744** [www.LaughlinHomes.net](http://www.LaughlinHomes.net)



**#1 RATED RV RESORT IN S. TEXAS TROPICS**  
Retama Village/Bentsen Palm Village. Spend  
a day, stay forever. Unbelievable amenities.  
RV Supersites \$40s. RV Port Home \$170s.  
**956-380-6500** [bentsenpalm.com](http://bentsenpalm.com)

## LEGAL SERVICES

**MONTANA LLC LAWYER • SAVE SALES TAX \$**  
on next RV purchase •Attorney operated.  
• Go with 36+ years experienced law firm.  
1-406-360-3409; [www.montanallcattorney.com](http://www.montanallcattorney.com)

## LOTS FOR SALE

**ESTERO, FL: GREAT 55+ RV RESORT** very  
unique park. 20 acre lake, htd pool, hot tub,  
too many amenities/activities to list. \$50K,  
possible owner fin. DVD avail. Call Mike 239-  
992-9378 or 239-218-4979.

## MAIL/MESSAGE SERVICES

**AMERICAS-MAILBOX Forwarding in SD**  
LOW Rates/NO State Income Tax/Save \$\$\$  
NO Wheel Tax/NO Safety Inspect/866-747-3700  
[www.Americas-Mailbox.com/TL](http://www.Americas-Mailbox.com/TL) Call us first!

## MOTORHOMES FOR SALE



**PRE-OWNED MOTORHOMES & RVs**  
Great selection! Consignments wanted.  
Florida's largest RV consignment center.  
View videos online of RVs in inventory.  
[www.CharlotteRV.com](http://www.CharlotteRV.com) 877-883-5555

## RECREATIONAL VEHICLES FOR SALE



**ALL MOLDED FIBERGLASS TRAVEL TRAILERS**  
Lightweight, Aerodynamic, Self-contained,  
Remarkably Spacious Floorplans, Exceptional  
Storage. Call for a FREE Brochure.  
CASITA TRAVEL TRAILERS • 1-800-442-9986



**SELL YOUR RV FAST! Online at RVT.com**  
Reach Millions of RV Buyers with a FREE AD  
50,000 RVs For Sale — By Owner and Dealer Listings  
[www.RVT.com](http://www.RVT.com) or 1.888.479.1099



**#1 RV MARKETPLACE -- SELL YOUR RV FAST!**  
Reach Over 1 Million Buyers Every Month  
Over 75,000 Listings -- New and Used RVs  
Where RVers go to BUY! [www.RVTrader.com](http://www.RVTrader.com)

## RV REGISTRY

[www.rvregistry.com](http://www.rvregistry.com)  
Motorhomes, Trailers & Fifth Wheels  
For Sale by Owners  
No Sales Commissions  
Buyers/Sellers 800-546-8457

## RECREATIONAL VEHICLES WANTED



**DONATE RVs, BOATS, PLANES, CAR/TRUCKS,**  
REAL ESTATE, SECURITIES or other real  
property. Receive an IRS tax receipt from a  
registered charity. International Ministry,  
800-871-1962. [streamofgodministries@gmail.com](mailto:streamofgodministries@gmail.com)



# CLASSIFIEDS

## SERVICES

### #1 IN SALES TAX SAVINGS

Pay no sales tax! We have helped 1000's save over the past 15 yrs. Call & talk to a CPA for professional, friendly service! [www.rvtax.com](http://www.rvtax.com)  
**Mountain States Consulting 800-565-4504**

### WHY IMPOSE ON FRIENDS?

Ask about our low cost personalized services: 15 years experienced • Mail and Vehicle Tags 1-888-494-4499 [www.myhomeaddressinc.com](http://www.myhomeaddressinc.com)

**Let us help you BUY YOUR RV ... TAX FREE!**  
**We guarantee BEST service and price**  
**Receive \$100 Gas Card & FREE Mail Fwding**  
**Call 888.430.3388 [www.MontanaRV.net](http://www.MontanaRV.net)**

### ACTION SERVICES, LLC

Consult a Licensed Montana Attorney  
 No Sales Tax in MT — Low License Fees  
 Financing & Insurance — For Professional Service  
 Call 800-481-0013 [www.actionservices-mt.com](http://www.actionservices-mt.com)

## TOURS



**RV Tours & Rallies across North America**  
 Alaska • Canada • USA • Mexico + Overseas  
 Visit [www.AdventureCaravans.com](http://www.AdventureCaravans.com) or  
 call for your FREE Catalog **800-872-7897**

### CLOTHING-OPTIONAL & NUDE GETAWAYS

A unique selection of RV resorts, parks, clubs, inns & cruises - UK & Caribbean.  
[www.tanr.com/rv](http://www.tanr.com/rv)

## TOW VEHICLE/TRAILER PACKAGES



**2005 M2 FREIGHTLINER, 43K MILES, AUTO, RR seat bed, all air ride, KBB book \$78K and 40' TETON, gen, W/D, D/W, sat, new: lthr furn-TV-paint, Bose snd, KBB book \$42K. Both \$89K 623-451-7121**



**2003 FREIGHTLINER 4 DR 300 CAT, 45K MI, Auto, air ride-seats-cab-susp, huge storage, & 2000 TETON 40', 4 S/O, 2BR or 1BR & office, oak & Corian, gen, D/W, W/D, 623-451-7121.**

## TOW VEHICLES FOR SALE



**2010 M2-FREIGHTLINER, 300 HP! 15MPG!** Sound-proof interior, auto, all Air Ride, leather, wood dash & console, deluxe RV body, 33K LB RV rating. Huge tool boxes. 888-838-6678, [ww.MountainMaster.net](http://www.MountainMaster.net)



**2005 4 DR DODGE 3500 DUALS HO Cummins 6 sp stick, 20 mpg, 60K mi, Mountain Master hydraulic bike loader & storage system. 85% Mich tires, Amsoil, 2 wh drive, leather. 623-451-7121.**



**70" AERO-CONDO CREW CHIEF RV HAULER, 300 Cat auto. Carpet, oak cabinets, refer, micro, rr sofa, B/U cam, arctic insul, extra storage. 14 MPG solo, low mi. 623-451-7121.**

**WANTED: USED MOUNTAIN MASTER RV TRUCKS.** Please call if you need to sell your medium duty RV truck or Teton 5th wheel. **WE SELL TRUCKS.** 623-221-2005, [www.mountainmaster.net](http://www.mountainmaster.net)

## TRAVEL TRAILERS/5TH WHEELS



**NEW 2012 Heartland Landmark Grand Canyon:** Loaded Only \$66,900! Guar Best Price! Call for info. 877-317-2688. New units-Loaded. Cust order avail no chg. View New/Used Units. [rvs4less.net](http://rvs4less.net)



**Eggcamper LIGHTWEIGHT AERODYNAMIC** EASY TOW MOLDED FIBERGLASS travel trailer EASY CLEAN MOLDED INTERIOR  
[www.eggcamper.com](http://www.eggcamper.com), 616-437-9255



**NEW 2012 MOBILE SUITES 36 TKS B3:** Loaded Only \$84,600! Ask For Our Magazine Reader's Discount. New units-Loaded. Cust order avail at no chg. Guar Best Price! More info at 877-317-2688. View Full Line of New/Used Units. [www.rvs4less.net](http://www.rvs4less.net)



**Little Guy Teardrop Camping Trailer** 12V-115, queen/king beds, sink/stove available So Light Any Car Can Tow! **\$4995**  
 Web: [www.golittleguy.com](http://www.golittleguy.com) Call 877-545-4897



CAMPGROUNDS ON THE NET!

[WWW.TLDIRECTORY.COM](http://WWW.TLDIRECTORY.COM)



**AWARD® TRAVEL TRAILERS**

Parts-Service, Repairs & Restorations  
Refurbished & Consignment Awards for Sale  
Call: 905-774-9351 www.awardrv.com

**VEHICLES FOR TRADE**



**2006 CHEV SILVERADO DIESEL DUALLY,**  
ALLISON, 4-dr crew, 83K mi. CB, CD  
Bose, Onstar, new tires, hitches. **TRADE**  
FOR FREIGHTLINER RV truck, prefer 4-dr  
Mountain Master. 817-773-4581.

**CLASSIFIED  
RATES**

**PRIVATE PARTIES:** \$30 per line,  
four-line minimum. Add \$65 for  
color photo. **All red text add \$25.**

**COMMERCIAL:** \$72 per line, four-  
line minimum, 40 characters per  
line. For photo ads (*limited to  
RVs and real estate*), add \$95  
B/W or \$115 color. For logo add  
\$95 B/W, \$115 color. No category  
limitations for logos. **All red text  
add \$50.**

**PAYMENT:** Check, VISA, Master-  
Card, Discover, American Express.

**EMAIL:** sseidlitz@goodsamfamily.com

**PHONE:** (530) 268-3005

**FAX:** (530) 653-2090

**MAIL:**

Trailer Life, Attn: Classified Dept. 10556  
Combie Rd. #6443 Auburn, CA 95602



# Let The GOOD TIMES Roll.

Just roll into any one of our 1,900 locations across the U.S. and Canada, and you'll find high quality campground and RV park accommodations. And Good Sam Members always receive 10% off on their overnight stay. Consult the *Trailer Life Directory* for full listings of all our campgrounds and facilities.



## Good Sam Parks

For more information about Parks or Directory call 800-234-3450





You've Come a Long Way RVing...  
And so have we!



## GET YOUR 2012 TRAILER LIFE DIRECTORY AT A RETRO PRICE!

Trailer Life Directory buyers say that the best way to plan their RV adventures is to use the Directory as their RV travel guide book. It's packed with over **11,700 up-to-date, comprehensive listings on RV parks, campgrounds, RV travel services, and things to see and do.**

Good Sam Members  
**SAVE EVEN MORE**  
when you order!

Get your 2012  
Trailer Life Directory  
at the *Retro Price!*

Just **\$15.95**  
Regular Retail Price \$24.95

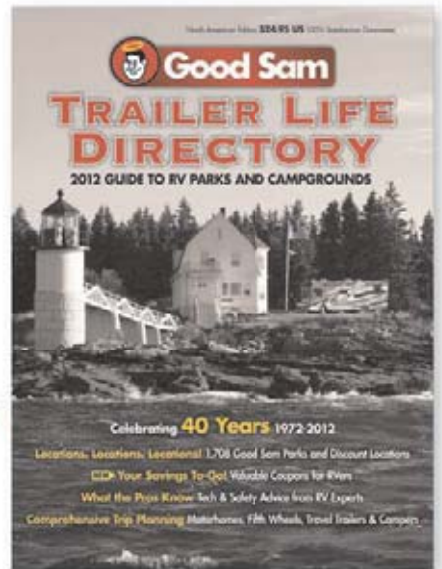

**DON'T MISS OUT - ORDER NOW!** Just call us **Toll Free at 1-877-209-6655** and mention **code 2AWO** or visit [www.TrailerLifeDirectory.com/RetroPrice](http://www.TrailerLifeDirectory.com/RetroPrice) to order online.

# AMERICA'S OUTBACK

by Bill Graves

## WI-FI ON THE ROAD

**"MCDONALD'S EATERIES ARE IN SMALL TOWNS EVERYWHERE, AND MOST OF THEM HAVE WI-FI."**

I'm at McDonald's in Salem, Indiana. It's getting so I am at a McDonald's someplace every few days, but seldom for the reasons most people are. I come here to use its free Wi-Fi (wireless broadband service) to keep in touch with the outside world, and with mine, too.

Keeping in touch for many of us means that we have to get on the Internet every day. I also use it to do research and read newspapers.

Most RVers get online when hooked up at an RV park. Others have network cards that allow their computers to "talk to the Internet" wherever they have cell-phone service. But for the roamers of the backroads who are often deep in the boonies, they cannot depend on phone service or even the existence of an RV park.

But McDonald's eateries are in small towns everywhere, and most of them have Wi-Fi. And they are open early and late.

McDonald's does not require a password to get on its wireless system. So I just walk in, find an electric outlet, if I need one — open my laptop and I am up and running. Next it's a visit to the counter for a "senior" coffee — same McCaf<sup>®</sup> coffee, just discounted for the geriatric set. Here it's 50 cents. And refills are free.

Since I'm usually here in the morning for at least an hour, I eventually get a couple breakfast burritos.

Jeremy Lowery, wearing a blue cap emblazoned with the "M" of the Golden Arches, was sitting by the door behind his opened laptop. Jeremy is supervisor of three McDonald's in the area that his mother owns.

I asked, "How do you feel about people like me who take up a booth for half of the morning?"

"We love it," he said. "In fact, we put that plug where you're sitting just for what you're using it. People come here for all sorts of reasons. That's fine with us."

In a booth across from me, a mother was helping her young daughter with her schoolwork. They each had drinks with whipped cream on top. They worked quietly and steadily for an



The familiar sight of the Golden Arches means so much more than a Big Mac; Supervisors such as Jeremy Lowery appreciate the traffic that free Wi-Fi brings to their restaurants.

hour. The mother told me that she homeschools her three children. "One day a week my 12-year-old and I come here to study. It's a treat for both of us," she said.

I told Jeremy about my "fast food" experience of minutes earlier: "One girl took my coffee order. She handed my dollar to the girl at the register, who was giving me change as the other one gave me the coffee. The whole thing took about 20 seconds."

Jeremy laughed. "I played football in high school; now I'm a coach. I'm a believer in teamwork and competition. We teach that around here. I have 80 crew employees, roughly 18 working at any one time. They learn to work together."

Jeremy said a burrito takes 17 seconds to get from order to the customer's tray. He figures if keeping score makes kids play harder in sports, here it makes them work faster.

He said 72 percent of his business is of the drive-through variety. "You lose me there," I told him. "When I spend the day behind the wheel, it is not my first choice of where to have lunch."

Another wireless option in a small town is the library. If they don't have Wi-Fi or data ports, they at least have computers available for Internet access. Unfortunately, they are not open the hours that McDonald's is, and they are seldom open on Sunday. And I can guarantee: It's a rare library that serves coffee in 20 seconds.

Welcome to America's Outback. ☺

**Bill's email address:** roadscribe@aol.com.

Next month Bill will be on the Door Peninsula in Wisconsin.



2012  
Diesel Applications Available  
[www.bulldog.com](http://www.bulldog.com)

# Pull **FASTER, FURTHER & SAFER** with **BULLY DOG** Tuning



- Increase Horsepower & Torque
- Improve Fuel Economy with Real Time Feedback (*Driving Coach Software*)
- Maximize Safety with Automatic Defueling & Alert Notifications
- Expand Visibility with Multi Gauge Pack



To see the GT in action, scan the QR code below with your smartphone or go to [www.bulldog.com/towing.php](http://www.bulldog.com/towing.php)

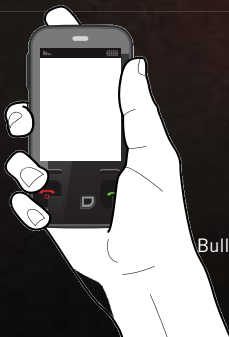

**BULLY DOG**  
*MAKING EVERY RIDE A BULLY!*

888-511-5773

Bully Dog, Circle 137 on Reader Service Card

Go To: **TRAILER**  
LIFE.com

User Guide

Contents



Welcome to our digital edition of Trailer Life Magazine. This format makes it easy for you to navigate the magazine and provides direct links to Internet sites of our advertisers, our TrailerLife.com Web site, and many Web sites to supplement our editorial features.

## Here are some tips on how to use Digital Trailer Life:



- Click on the TrailerLife.com button to go directly to our Web site.
- Click on the User Guide button on any page to bring you back to this page.
- Click on the Contents button to take you to the Table of Contents page from anywhere in the magazine.

- When the hand icon changes to a pointing  finger, it indicates a link to a Web site or to another page in the magazine.

- Use the Zoom  tool to zoom in on the page. Use the Zoom-out tool  and hold down the option (Macintosh) or Windows key to toggle back and forth.

- Click and drag using the Dynamic Zoom  tool to infinitely control the zoom.

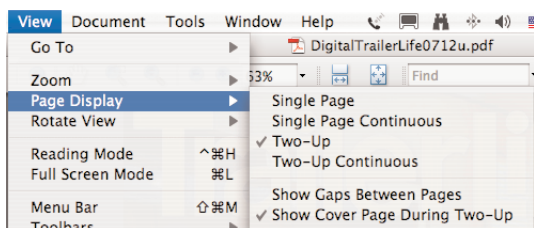

We recommend a Page Layout view of Two-Up (or Facing, depending on the version of Reader), Showing Cover Page, however, Adobe Reader provides several options you may prefer.

We hope you enjoy reading our Digital *Trailer Life* magazine, and we encourage your comments and suggestions to our editor at [kbunker@affinitygroup.com](mailto:kbunker@affinitygroup.com)